

Artificial Neural Network Algorithm for Condition Monitoring of DC-link Capacitors Based on Capacitance Estimation

Hammam Soliman, Huai Wang, IEEE Member, Brwene Gadalla, Frede Blaabjerg, IEEE Fellow
 Department of Energy Technology, Aalborg University,
 Aalborg 9220, Denmark,
 has@et.aau.dk, hwa@et.aau.dk, bag@et.aau.dk, fbl@et.aau.dk

Abstract - In power electronic converters, reliability of DC-link capacitors is one of the critical issues. The estimation of their health status as an application of condition monitoring have been an attractive subject for industrial field and hence for the academic research filed as well. More reliable solutions are required to be adopted by the industry applications in which usage of extra hardware, increased cost, and low estimation accuracy are the main challenges. Therefore, development of new condition monitoring methods based on software solutions could be the new era that covers the aforementioned challenges. A capacitance estimation method based on Artificial Neural Network (ANN) algorithm is therefore proposed in this paper. The implemented ANN estimated back converter. Analysis of the error of the capacitance estimation is also given. The presented method enables a pure software based approach with high parameter estimation accuracy.

Keywords - Capacitor condition monitoring; capacitor health status; Capacitance estimation.

I. INTRODUCTION

Condition monitoring is an important strategy to estimate the health condition of power electronic components, converters and systems. It is widely applied in reliability or safety critical applications, such as wind turbines, electrical aircraft, electric vehicles, etc., enabling the indication of future failure occurrences and preventive maintenances. In [1], the condition monitoring of semiconductor devices used in power electronics is well reviewed. Besides the power devices, and according to [2], electrolytic capacitors are sharing 60% of the failure distribution for power converter elements as shown in Fig.1, therefore, capacitors are another type of reliability critical components.

In the last two decades, a large number of research results on condition monitoring of capacitors has been published. The majority of the condition monitoring methods for capacitors are based on estimation of the capacitance C and equivalent series resistance (ESR), which are indicators of the degradation of capacitors [3]. For aluminum electrolytic capacitors, the widely accepted end-of-life criteria are 20% capacitance reduction or double of the ESR. For film capacitors, a reduction of 2% to 5% capacitance may indicate the reach of end-of-life. Therefore, a method which can estimate the C value could be applied on both aluminum electrolytic and film capacitors. However, obtaining the values of C or ESR is an important step since it gives an indication of the ageing process and its acceleration. Fig. 2(a) shows a simplified equivalent model of capacitors and Fig. 2(b) plots the corresponding frequency characteristics. It can be noted that the capacitor impedances are distinguished by three frequency regions dominated by capacitance, ESR and the Equivalent Series Inductance (ESL), respectively.

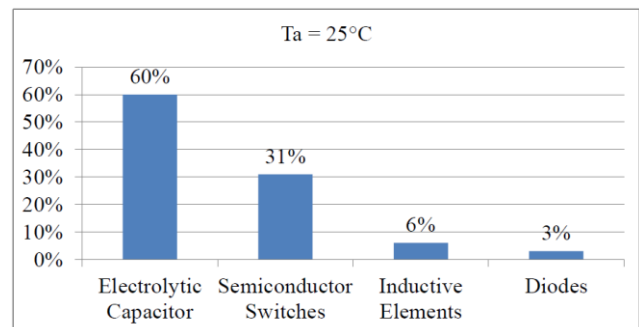
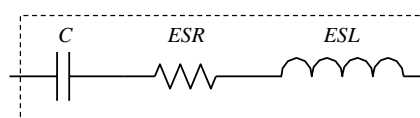

Fig. 1. Distribution of failure for power converter elements [2]



(a) Simplified equivalent model of capacitors

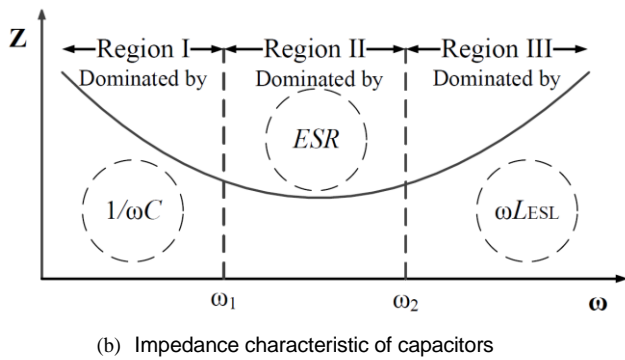

Fig .2. Equivalent model and impedance characteristics of capacitors.

From the methodology point of view in [4], condition monitoring methods in the literature are classified into three categories as the following: a) Capacitor ripple current sensor based methods, b) Circuit model based methods, and c) Data and advanced algorithm based methods. The following three subsections are defining the principle of each category with its corresponding examples from the literature.

A. Capacitor ripple current sensor based methods

The basic principle of the this category is to estimate the capacitance and/or the ESR by using the capacitor ripple voltage and current information at region I and II (as shown in Fig. 2(b)). In [2, 5–7], an external current injection at low frequency is the main approach to achieve condition monitoring, it has been applied to PWM AC/DC/AC converter in [2], [5], and [7], while in [6] it has been applied to a submodule capacitor in moulder multilevel converter.

B. Circuit model based methods

This category is based on that instead of injecting external signals, the capacitor current can be obtained indirectly depending on both the circuit model and the operation principle of PWM switching converters. In [8], an on-line condition monitoring based on capacitance estimation is proposed, the capacitor ripple current is calculated using the difference between the input current sensor, and the output current flows to the inverter which is based on the transistor switching statuses.

C. Data and advanced algorithm based methods

This category, obtaining a strong correlation between the available parameters and the parameters to be

estimated is the main concept. In [9], an external voltage is injected to the reference voltage of the capacitor at low frequency, the obtained capacitor power is used as a training data in sake of finding an identification model based on Support Vector Regression (SVR). After using a group of training data, a generated function is used to analyse the correlation between the known capacitor power and its corresponding capacitance value. Although the previous mentioned methods have been verified by simulation and experimental work, errors, complexity, and cost increasing due to extra hardware are common shortcomings. Therefore, the developed technologies are rarely adopted in practical industry applications, implying that new condition monitoring methods based on software solutions and existing feedback signals, without adding any hardware cost, could be more promising in practical applications.

This paper aims to propose a condition monitoring method based on Artificial Neural Network (ANN) that uses existing power stage and control information and existing spare resources of digital controllers. It requires no extra hardware circuitry (e.g., current sensors and corresponding signal condition circuits), no external signal injection, and therefore minimises the increased complexity and cost. Main sections in this paper are as the following: Section II gives the basic principle of ANN applied for capacitor condition monitoring. Section III

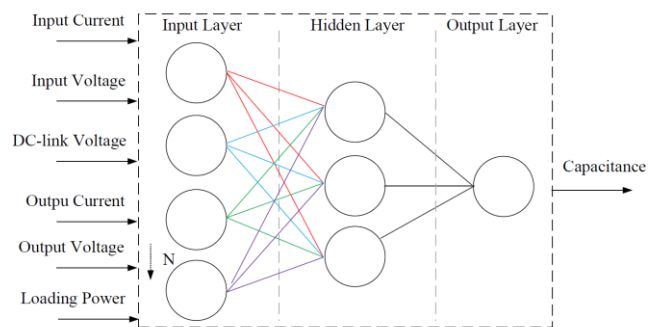

Fig .3. The structure of the Artificial Neural Network.

illustrates the applied ANN to a back to back converter study case. Section IV presents the results achieved by the proposed method based on ANN, followed by the conclusion.

II. ANN FOR CAPACITOR CONDITION MONITORING

Implementation of capacitor condition monitoring

using ANN is motivated by the shortcomings that have been investigated earlier in this paper. Avoiding the usage of direct/indirect current sensors is one of the main advantages of using ANN to obtain the estimated value of C. Instead of sensing the capacitor current i_C , only the input terminal and output terminal information of the power converters are used as inputs to the ANN, while the capacitance is the ANN's target, and then the network is responsible for estimating the value of C when using different inputs than the trained ones. Normally, during the operation of the power converter, the required terminal information to train the ANN is supposed to be available. Taking the power level of the applied converter into consideration while the network is trained, is improving the ANN's estimated results by being more robust against dynamic variations of the loading power. Fig.3 illustrates the structure of the proposed ANN. The basic structure of any neural network consists of three layers, input, hidden, and output layers. The input layer is where the available amount of data N fed to the ANN will be stored. The

hidden layer job is to transform the inputs into a function that the output layer can use, while the output layer transforms the hidden layer activations into a scale which the operator wanted the output to be on target.

III. CAPACITANCE ESTIMATION BASED ON ANN

Capacitance estimation based on ANN is applied to a back to back converter as shown in Fig. 4. The specifications of the converter are listed in Table I.

Capacitance values in the range between (1000 μ F and 5000 μ F) with 100 μ F step are used as targets to the network, each value of these 41 samples corresponds respectively to the single phase RMS input/output voltages, currents, and the DC-link voltage. Since the different loading condition of the back-to-back converter is also considered, three groups of 41 samples under the respective loading level of 10 kW, 7 kW and 4 kW are used.

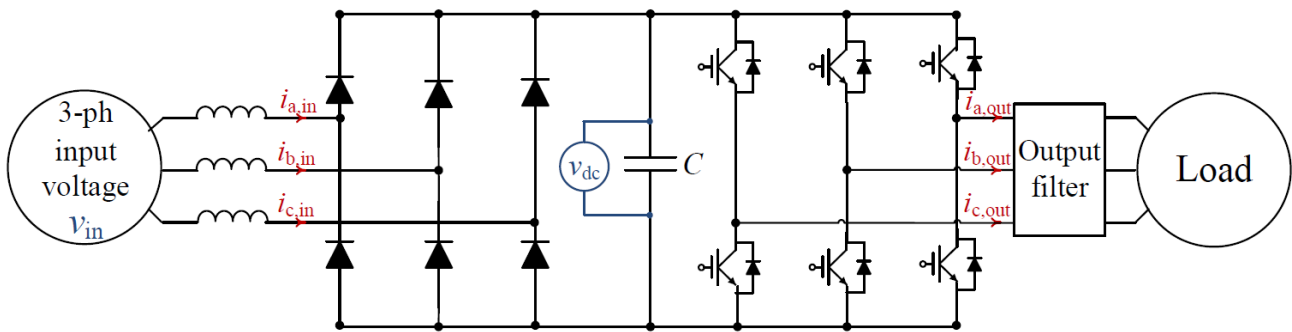

Fig .4. A back-to-back converter.

Table 1. THE SPECIFICATIONS OF THE BACK-TO-BACK CONVERTER PARAMETERS.

Input AC Voltage (VL-L)	600 V
Output AC Voltage (VL-L)	380 V
Rated DC-link Voltage (Vdc)	780 V
Full Power Level (Po)	10 kW
Capacitance (C)	5000 μ F

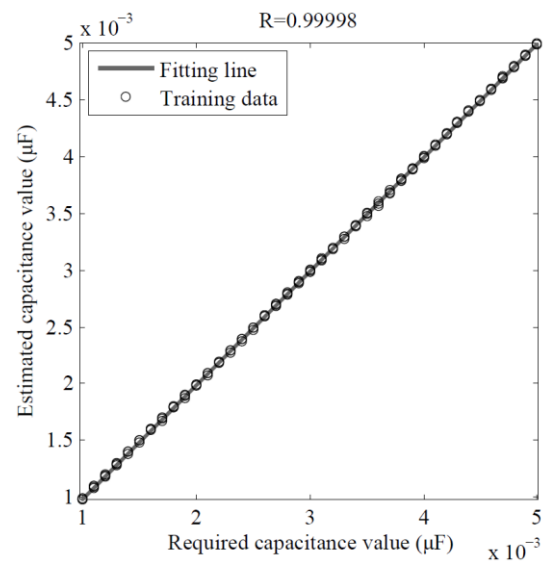

Fig .5. Regression response of the trained network..

All the 123 samples are fed to a single hidden layer ANN consisting of 10 neurons using the Neural Fitting Tool (nftool) in MATLAB software. This tool is usually used for estimation and prediction of problems in which the neural network maps between a data set of numeric inputs and a set of numeric targets. The iteration algorithm used in this training is Levenberg-Marquardt, which typically takes more memory but less time. The training automatically stops when generalisation stops improving, as indicated by an increase in the mean square error of the validation samples. During the training observing the Regression value R is important, since Regression values measure the correlation between outputs and targets. An R value of 1 means a close relationship, while 0 means a random relationship. Fig. 5 shows the regression response of the trained network in this paper. It can be noted that all the

123 input data are exactly aligned on the fitting line and the values of R are close to 1. Based on this result, the network stopped training and the ANN is generated to be used.

IV. SIMULATION RESULTS AND DISCUSSION

In this section, the trained network is tested for verification purpose. The inputs to the ANN are stored in the Matlab work- space, and they are sent to the ANN as a group set every 0.2 seconds. Each group set is resulting in one corresponding output (estimated C value). The same group set of inputs is sent until a new set is available in the work-space. The same back to back converter as shown in Fig. 4 is used for the simulation test, but with two capacitors C1 and C2 connected in parallel through switches to have the option to switch between them to simulate the degradation of C. At the timing (5 sec) the capacitor C2 will be switched on instead of C1 . Fig.6 shows the capacitance value estimated by the trained ANN. The simulation results for the estimated parameters and their corresponding errors are shown in Table II. The estimated results verify that the trained ANN is responding for the changes in the capacitance value, and the statues of the capacitor could be easily identified.

Table 2. SIMULATION RESULTS FOR ESTIMATED CAPACITANCE..

$C1_{actual}=5000\mu F$	$C1_{estimated}=4991\mu F$	Error=0.18%
$C2_{actual}=4000\mu F$	$C2_{estimated}=3996\mu F$	Error=0.1%

Moreover, to prove the accuracy of the trained ANN, the network is tested to identify the reduction of 50μF out of 5000μF and the resulted estimation is shown in Fig. 7. For the initial stage, the estimated value is 4991μF and for the degraded case, the estimated value is 4945μF, which gives a 0.18% error as a maximum.

To test the robustness of the trained ANN against loading power variations, the ANN is tested to estimate a capacitance

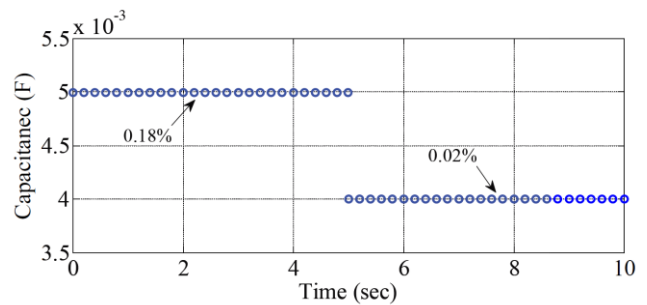

Fig .6. Tested DC-link capacitor change in a back-to-back converter.

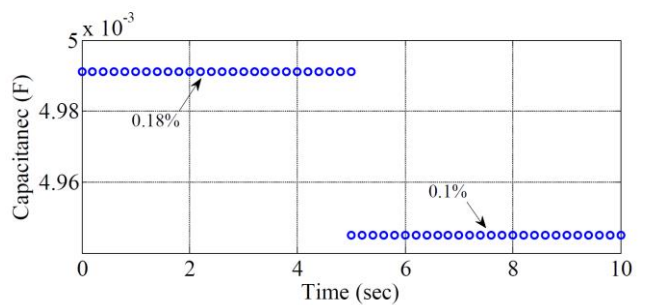

Fig .7. Trained ANN accuracy for the capacitance change shown in Fig. 6.

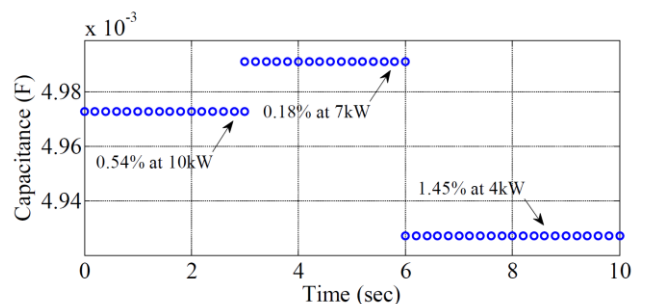

Fig .8. Trained ANN accuracy for the loading power change.

value of 5000μF during a loading power change. The esti- mated results with their corresponding errors percentage are shown in Fig. 8.

Moreover, for further verification of the ANN accuracy, a set of random values of capacitance between the ranges of (1000 μ F-5000 μ F) are applied under three different power levels, their actual and estimated values are shown in Fig.9. The actual and estimated values of capacitance of the set applied under 70% power level are presented in Table III.

In sake of showing the impact of the training data amount on the accuracy of the trained ANN, another network (ANN2) is trained by using 63 samples instead of 123 samples considering the same conditions of (ANN1) which have been trained earlier in this paper. Fig. 10 shows that the errors estimated by ANN2 are higher than the ones estimated previously by ANN1, implying the trade-off between estimation accuracy and required computation resource.

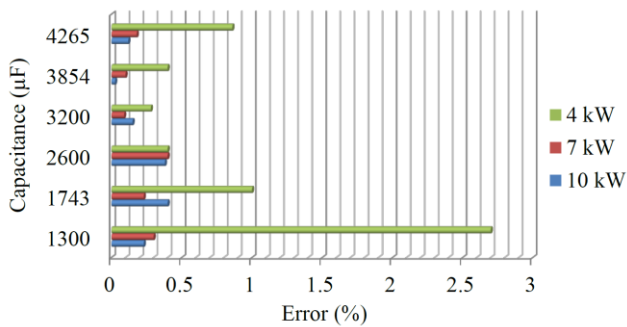

Fig. 9. Estimation error analysis under different level of power.

Table 3. SIMULATION RESULTS FOR ESTIMATED CAPACITANCE (AT 7KW).

$C_{actual}=1300\mu F$	$C_{estimated}=1296\mu F$	Error=0.3%
$C_{actual}=1743\mu F$	$C_{estimated}=1747\mu F$	Error=0.23%
$C_{actual}=2600\mu F$	$C_{estimated}=2589\mu F$	Error=0.4%
$C_{actual}=3200\mu F$	$C_{estimated}=3203\mu F$	Error=0.09%
$C_{actual}=3854\mu F$	$C_{estimated}=3850\mu F$	Error=0.1%
$C_{actual}=4265\mu F$	$C_{estimated}=4257\mu F$	Error=0.18%

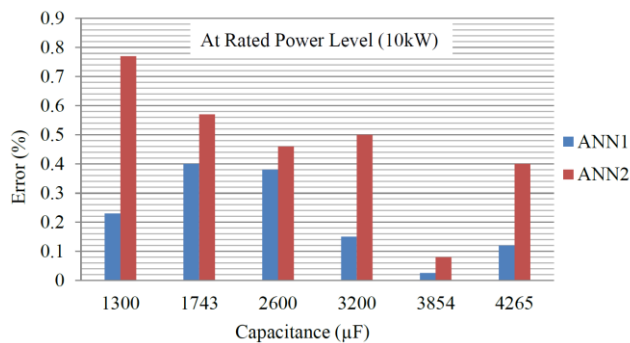

Fig. 10. Estimation error analysis by different trained ANNs.

The last accuracy analysis is performed to observe the error percentage of the estimated capacitance with respect to different degree of changes of the original value of 5000 μ F, the results are shown in Fig. 11. It can be noted that the estimation errors of the proposed ANN are below 0.25%. It can respond and estimate correctly the capacitance values even under a very low level of capacitance reduction of 0.2% changes.

The following remarks are given from the results presented in this section:

- The simulation results of the proposed method based on ANN verify that condition monitoring methods based on software solutions could be an attractive alternative for the practical industry applications.
- It can be noted from the results that trained ANN is capable to respond to a very small change of capacitance

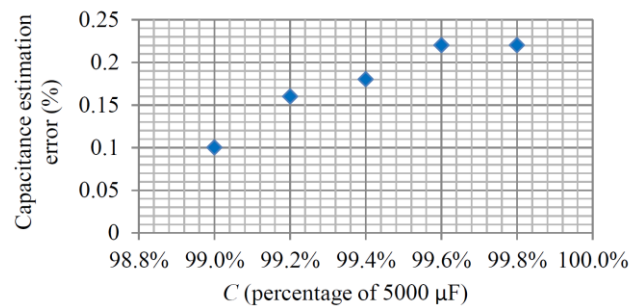

Fig. 11. Estimation error analysis under different level of capacitance reduction at rated power level.

and estimate the capacitance value within the range in which the network is trained.

- It should be noted that the accuracy of the trained ANN strongly depends on the amount, quality, and accuracy of the data used in the training.

V. CONCLUSIONS

A new capacitor condition monitoring method based on Artificial Neural Network algorithm is proposed in this paper. It is applied to a back-to-back converter study case to estimate the capacitance value change of the DC-link capacitor. The proposed method requires no additional hardware circuit and could be implemented by using the spare resources of existing

digital controllers in most of power electronic systems, implying a minimum increased cost (e.g., only in the research and development part). The error analysis under different DC-link capacitance values and different level of capacitance reduction with respect to the initial value are given, achieving a maximum estimation error that is well below 0.5%, which could be acceptable in many practical applications. The impact of training data amount on the error analysis is also given.

REFERENCES

- [1] S. Yang, D. Xiang, A. Bryant, P. Mawby, L. Ran, and P. Tavner, "Condition monitoring for device reliability in power electronic converters: A review," *IEEE Transactions on Power Electronics*, vol. 25, no. 11, pp. 2734–2752, Nov 2010.
- [2] X.-S. Pu, T. H. Nguyen, D.-C. Lee, K.-B. Lee, and J.-M. Kim, "Fault diagnosis of dc-link capacitors in three-phase ac/dc pwm converters by online estimation of equivalent series resistance," *IEEE Transactions on Industrial Electronics*, vol. 60, no. 9, pp. 4118–4127, Sept 2013.
- [3] H. Wang and F. Blaabjerg, "Reliability of capacitors for dc-link applications in power electronic converters-an overview," *IEEE Transactions on Industry Applications*, vol. 50, no. 5, pp. 3569–3578, Sept 2014.
- [4] H. Soliman, H. Wang, and F. Blaabjerg, "A review of the condition monitoring of capacitors in power electronic converters," in *Electromotion Joint International Conference (ACEMP - OPTIM)*, 2015 IEEE, August 2015, pp. 243–249.
- [5] D.-C. Lee, K.-J. Lee, J.-K. Seok, and J.-W. Choi, "Online capacitance estimation of dc-link electrolytic capacitors for three-phase ac/dc/ac pwm converters using recursive least squares method," in *Proceedings of Electric Power Applications*, vol. 152, no. 6, pp. 1503–1508, Nov 2005.
- [6] Y.-J. Jo, T. H. Nguyen, and D.-C. Lee, "Condition monitoring of submodule capacitors in modular multilevel converters," in *Energy Conversion Congress and Exposition (ECCE)*, 2014 IEEE, Sept 2014, pp. 2121–2126.
- [7] T. H. Nguyen and D.-C. Lee, "Deterioration monitoring of dc-link capacitors in ac machine drives by current injection," *IEEE Transactions on Power Electronics*, vol. 30, no. 3, pp. 1126–1130, March 2015.
- [8] A. Wechsler, B. Mecrow, D. Atkinson, J. Bennett, and M. Benarous, "Condition monitoring of dc-link capacitors in aerospace drives," *IEEE Transactions on Industry Applications*, vol. 48, no. 6, pp. 1866–1874, Nov 2012.
- [9] A. Abo-Khalil and D.-C. Lee, "Dc-link capacitance estimation in ac/dc/ac pwm converters using voltage injection," *IEEE Transactions on Industry Applications*, vol. 44, no. 5, pp. 1631–1637, Sept 2008.