

## A FATIGUE DAMAGE ACCUMULATION METHOD IN LOW – CYCLE FATIGUE ZONE

STANISŁAW MROZIŃSKI

*Faculty of Mechanical Engineering, University of Technology and Agriculture  
e-mail: stmpkm@mail.atr.bydgoszcz.pl*

A summation method of the fatigue damage in a low cycle fatigue zone is proposed in the paper. The method is based on a fatigue curve revolution, with the fatigue curve in the  $\varepsilon_{ac} - 2N_f$  co-ordinate system as a base line. The low-cycle properties and parameters of a loading program are necessary for fatigue life calculations.

Experimental verification of the proposed hypothesis (one material, two types of loading: random and programmed) showed a satisfactory agreement between the test and calculation results. A comparative analysis between the calculation results obtained using the linear damage rule (LDR) and those resulting from the method proposed, showed several advantages of the latter one. These are; e.g., the fact that the results obtained are located in the safe fatigue life area, simplicity of the method and sensitivity to the parameters of a loading program.

*Key words:* fatigue life, fatigue damage accumulation, low-cycle fatigue

### Notation

- $b$  – elastic exponent
- $c$  – plastic exponent
- $E$  – modulus of elasticity, [MPa]
- $i$  – number of strain programme loop
- $j$  – a strain level in a programme
- $k$  – total number of levels in the programme
- $n_o$  – total number of cycles in the strain programme (block contents)
- $n_j^i$  – number of cycles for the  $j$ th strain level and the  $i$ th loop of the programme
- $n_c$  – number of cycles performed until fatigue failure in the case of random or programmed loading

$2N_f$	–	reversals to failure
$N_{f(ran)}$	–	fatigue life for the random loading
$N_{f(prog)}$	–	fatigue life for the programmed loading
$N_{fj}$	–	fatigue life for the constant amplitude strain $\varepsilon_{acj}$
$\varepsilon_{ac}$	–	amplitude of the total strain
$\varepsilon_{acj}$	–	amplitude of total strain for the $j$ th strain level
$\Delta\varepsilon_{ac}$	–	total strain range
$\Delta\varepsilon_{ae}$	–	elastic strain range
$\Delta\varepsilon_{ap}$	–	plastic strain range
$\varepsilon'_f$	–	fatigue ductility coefficient
$\lambda$	–	number of strain programme loops
$\sigma'_f$	–	fatigue strength coefficient, [MPa]
$\zeta$	–	coefficient of spectrum density.

## 1. Introduction

Fatigue life calculations of the structural parts subject to service loading are strongly connected with the problem of fatigue damage accumulation. In the literature there can be found descriptions of various fatigue damage accumulation methods (Palmgren, 1924; Miner, 1945; Corten and Dolan, 1956; Mansson and Halford, 1986). However, many hypotheses have no physical backgrounds. The simplest and most often applied is the Palmgren (1924) and Miner (1945) hypothesis of fatigue damage accumulation, which is known as the Linear Damage Rule (LDR), as well as its modifications (Wallgren, 1949; Serensen and Kogaev, 1966; Haibach, 1970). Basing on the analysis of test results and the phenomena accompanying the fatigue process in the 1970 several hypotheses of damage accumulation based on the fatigue curve convergence and revolution were formulated (Schott, 1981; Hashin and Rotem, 1978; Subramanyan, 1976; Szala, 1981). They held mainly when the stress approach to the fatigue process was applied.

With the fatigue process being recognised better and better and the research progress in the field of low-cycle fatigue, the development of new calculation methods in both the strain and energy approach has proceeded (Colins, 1993). These methods can be applied to prediction of fatigue life of the structural parts for which the distribution (history, spectrum) of service loading comprises low and high-cycle fatigue life domains. In the first work dealing with the cumulative fatigue damage in the low-cycle fatigue zone (Tucker, 1972) there was accepted the LDR concept. The discrepancy between cal-

ulation and test results reached 300%. Ellyin and Kujawski (1984), Gołóś and Ellyin (1987), Kujawski and Ellyin (1984) proposed the hypotheses based upon the fatigue curve convergence and revolution in terms of the energy approach. In these papers an acceptable agreement between the experimental and calculation results was achieved.

For the energy hypotheses to be applied to the description of damage cumulation the knowledge of low cycle properties of the material and loading program parameters is necessary. A main obstacle to the application of energy hypotheses is the necessity for calculating the plastic strain energy  $\Delta W_{pl}$  (corresponding to the area of hysteresis loop). Eventually, it involves differentiation of the test and calculation results depending e.g. on the method of hysteresis loop area calculation. A more suitable approach seems to be summing up the fatigue damages resulting from a standard tests, e.g. from the fatigue life curve in the  $\varepsilon_{ac} - 2N_f$  co-ordinate system. When using such a method there is no need for making any additional calculations. Another advantage of this method consists in the fact that the total strain resulting from the fatigue curve is measured directly during the test.

The paper aims mainly at formulating some assumptions and at experimental verification of a fatigue damage accumulation method taking the strain approach based on the  $\varepsilon_{ac} - 2N_f$  fatigue curve revolution. Additionally, a comparative analysis between calculation efficiency of the suggested method and known hypotheses of fatigue damage accumulation is necessary.

## 2. Description of the fatigue damage accumulation method

A basic characteristic diagram representing the properties of a material in the low-cycle fatigue zone is a fatigue curve in the  $\varepsilon_{ac} - 2N_f$  co-ordinate systems. Changes of total strain  $\varepsilon_{ac}$  and its components; namely, the elastic  $\varepsilon_{ae}$  and plastic  $\varepsilon_{ap}$  strain to number of reversals to failure  $2N_f$  are taken into account in the diagram. Sample fatigue life curve with its specific points is presented in Fig.1.

The fatigue life curve is determined basing on the results of constant amplitude fatigue test performed under stress-controlled or strain-controlled conditions. Low-cycle fatigue test results are approximated most frequently in terms of the Morrow equation (see Fig.1). Both the experimental and calculation procedures are standardised [1].

Analysis of the assumptions accepted by Schott (1983) when formulating the damage cumulation hypothesis based on the  $\sigma - N$  curve revolution shows

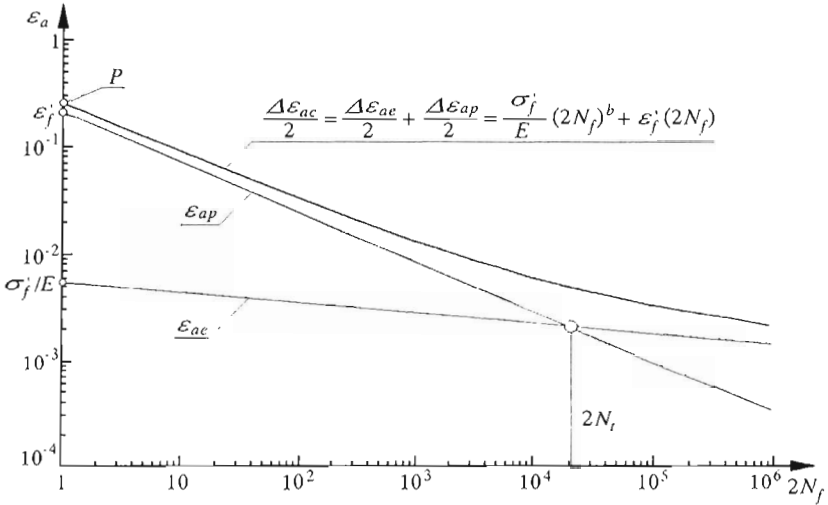

Fig. 1. Fatigue life curve in the  $\epsilon_{ac} - 2N_f$  co-ordinate systems

that a main difficulty in calculation methodology is a proper determination of the "remaining" life curves intersection point. As it was proved by Schott (1983), the position of this point on the diagram strongly affects the agreement between test and calculation results. On the fatigue life curve shown in Fig.1 we can define some specific points; e.g.,  $\sigma'_f/E$ ,  $\epsilon'_f$ ,  $P$ , each of them may act as the centre of revolution of a secondary fatigue life curve. Basing on that and making the assumptions of fatigue damage accumulation hypotheses in the stress approach presented by Schott (1981), Hashin and Rotem (1978), Subramanyan (1976), Szala (1981) in the present study the assumptions were formulated for damage accumulation hypotheses in the strain approach. These assumptions are presented in Fig.2.

The main assumptions of the damage accumulation description in the strain approach are as follows:

— base line is fatigue life curve described by equation

$$\epsilon_{ac} = \epsilon_{ae} + \epsilon_{ap} = \frac{\sigma'_f}{E} (2N_f)^b + \epsilon'_f (2N_f)^c \tag{2.1}$$

— intersection of fatigue life curve with the ordinate axis is the starting point of a family of curves ("remaining" life curves) represented by the equations

$$\epsilon_{acj} = \epsilon_{aej} + \epsilon_{apj} = \frac{\sigma'_f}{E} (2N_{fj})^{b_j} + \epsilon'_f (2N_{fj})^{c_j} \tag{2.2}$$

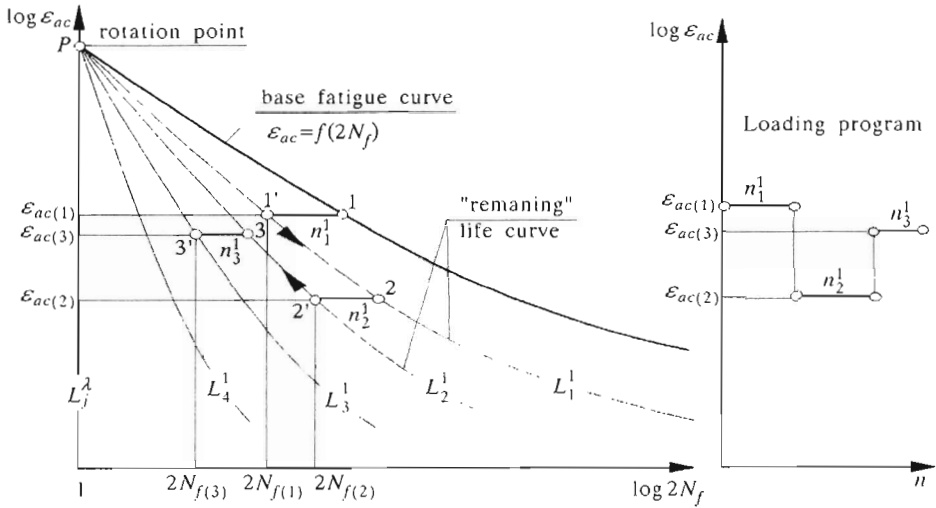

Fig. 2. Damage cumulative method based on the  $\epsilon_{ac} - 2N_f$  fatigue curve revolution for a programmed loading

where  $2N_{fj} = 2N_{j-1,j}^i - 2n_j^i$

— points  $\sigma'_f/E$  and  $\epsilon'_f$  are the centres of revolution of the family of lines which represent the changes in plastic and elastic strains defined by the equations

$$\epsilon_{aej}^i = \frac{\sigma'_f}{E} (2N_{fj})^{b_j^i} \quad \epsilon_{apj}^i = \epsilon'_f (2N_{fj})^{c_j^i} \quad (2.3)$$

— succeeding positions of the lines describing changes in plastic and elastic strain are determined by the slopes of regression lines  $b_j^i$  and  $c_j^i$  assuming that for succeeding lines positions the following condition is imposed

$$\frac{c}{b} = \frac{c_1^1}{b_1^1} = \frac{c_2^1}{b_2^1} = \dots = \frac{c_j^\lambda}{b_j^\lambda} \quad (2.4)$$

— fatigue life under a programmed loading equals the sum of cycle numbers at particular levels performed until the fatigue failure

$$n_c = \sum_{i=1}^{\lambda} \sum_{j=1}^k n_j^i \quad (2.5)$$

From Fig.2 it can be seen that the first level of the loading program with the strain amplitude  $\epsilon_{ac(1)}$  corresponds to the number of reversals to failure

$2N_f = 2N_1^1$  (point 1) at the base fatigue curve. After performing the  $n_1^1$  loading cycles at this level the remaining life corresponds to the point 1'. This point lies on the "remaining" life curve  $L_1^1$  represented by Eq (2.2). The point 2 corresponding to the remaining life  $N_2^1$  on the strain level  $\epsilon_{ac(2)}$  is located on this line. Realisation of the following levels of strain program enables one to determine the next "remaining" life curves  $L_3^1, L_4^1, \dots, L_j^\lambda$ . The line  $L_j^\lambda$  is the boundary line of "remaining" life curves and corresponds to the fatigue failure.

### 3. Experimental investigation

#### 3.1. Specimens for the fatigue test

The specimens used during fatigue tests were made of normalised 45-steel. Its chemical constitution was as follows: C - 0.45%, Mn - 0.593%, P - 0.015%, S - 0.027%, Cr - 0.016%, Fe - 98.1%. The following mean values of the ultimate tensile strength  $S_u = 700$  MPa and yield point  $S_y = 430$  MPa were chosen. The size and shape of the specimen prepared according to [1] are presented in Fig.3.

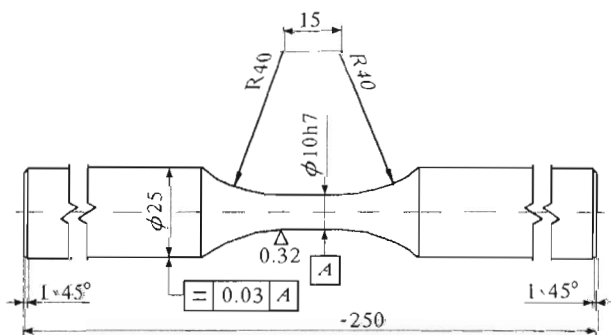

Fig. 3. Size and shape of the specimen for experiments

#### 3.2. Loading program

The fatigue tests were performed under constant amplitude and irregular loading conditions, respectively. Both the loading histories were strain-controlled. The amplitude distribution for irregular history was determined

using the following beta distribution

$$f(\epsilon_{ac}) = \frac{1}{B(\alpha, \beta)} \epsilon_{ac}^{\alpha-1} (1 - \epsilon_{ac})^{\beta-1} \tag{3.1}$$

where

- $B$  - beta function in terms of the gamma function,  
 $B(\alpha, \beta) = \Gamma(\alpha)\Gamma(\beta)/\Gamma(\alpha + \beta)$
- $\alpha, \beta$  - parameters of the beta distribution.

From changing the values of  $\alpha$  and  $\beta$  parameters different histories of random loading yielded. They were characterised by the maximum strain amplitude  $\epsilon_{ac\max}$  in one block of the loading program and by the coefficient of spectrum density  $\zeta$

$$\zeta = \sum_{j=1}^k \frac{\epsilon_j}{\epsilon_{ac\max}} \frac{n_i}{n_o} \tag{3.2}$$

Random time histories of strain were subjected to a cycle counting process using the peak counting method and the resulting spectra formed the basis on which each programmed loading was determined. The operations performed are schematically presented in Fig.4. The values of all parameters for the realised loading are shown in Table 1.

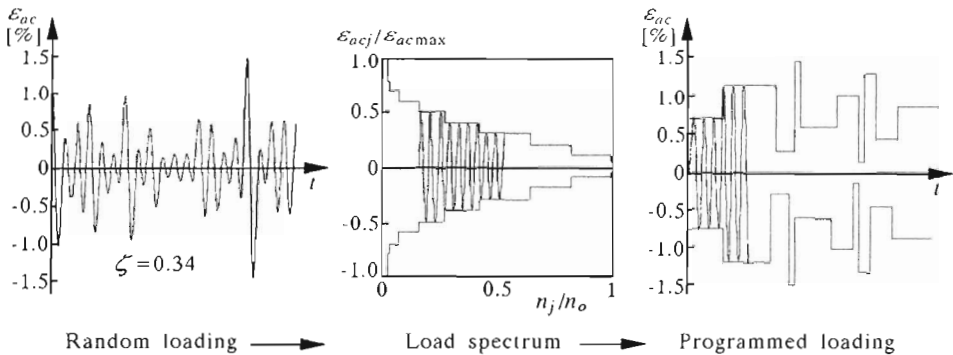
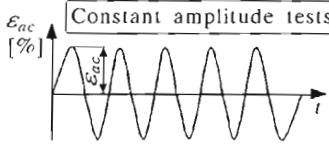
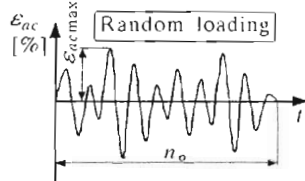
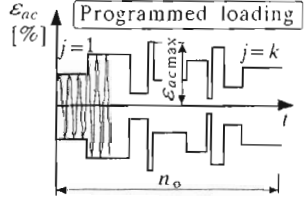

Fig. 4. Determination of the programmed loading

The fatigue tests were performed by means of the strength test machine Instron 8501. During the constant amplitude tests selected loading cycles were registered. For the irregular loading histories whole particular blocks of loading were registered ( $n_o = 100$  cycles).

Table 1. Parameters of the loading programmes

Load histories	Parameters
 <p>Constant amplitude tests</p>	$\varepsilon_{ac} = 0.35\%$ $\varepsilon_{ac} = 0.50\%$ $\varepsilon_{ac} = 0.80\%$ $\varepsilon_{ac} = 1.0\%$ $\varepsilon_{ac} = 2.0\%$ $f = 0.2\text{Hz}$
 <p>Random loading</p>	$\varepsilon_{ac\max} = 0.35\%$ $\varepsilon_{ac\max} = 0.50\%$ $\varepsilon_{ac\max} = 0.80\%$ $\varepsilon_{ac\max} = 1.0\%$ $\varepsilon_{ac\max} = 1.50\%$ $\zeta = 0.34$ $\zeta = 0.56$ $\zeta = 0.77$ $n_o = 100$ $k = 10$ $f = 1\text{Hz}$
 <p>Programmed loading</p>	

#### 4. Results of constant and variable amplitude tests

The results of tests under constant amplitude and irregular amplitude loading conditions are presented in the form of fatigue life curve in the  $\varepsilon_{ac} - f(2N_f)$  and  $\varepsilon_{ac\max} - f(2N_f)$  co-ordinate system (Fig.5).

All the loading histories considered were determined by the maximum total strain amplitude  $\varepsilon_{ac\max}$  and coefficient of spectrum density  $\zeta$ . As it was expected, with the growth of the latter one fatigue life is decreasing and getting closer to the constant amplitude test results ( $\zeta = 1$ ). However, a slight scatter of fatigue life results is observed for two various loading program histories (random and programmed). In order to describe this fact quantitatively the results obtained were arranged in a diagram in the  $2N_{f(\text{ran})} - 2N_{f(\text{prog})}$  co-ordinate system (Fig.6).

The points of the diagram lying above the diagonal line indicate the increase (for the same loading parameters  $\zeta$  and  $\varepsilon_{ac\max}$ ) in the fatigue life



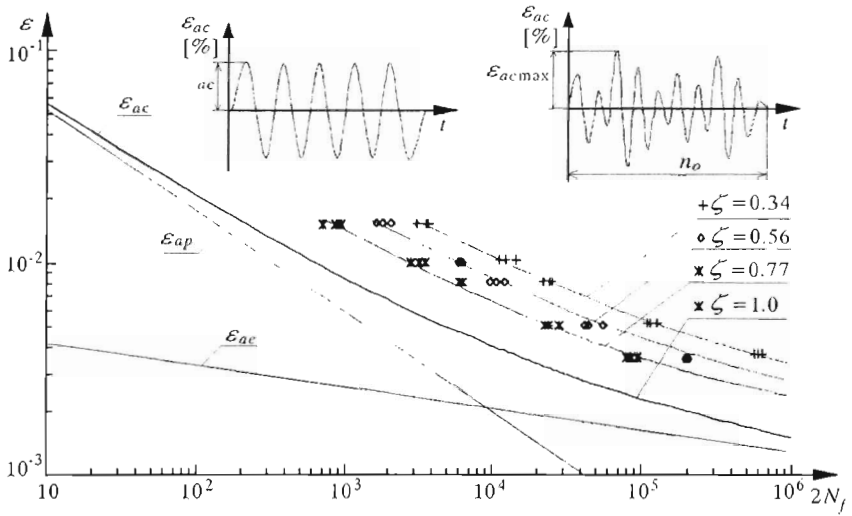

Fig. 5. Fatigue life of 45-steel under constant amplitude and irregular amplitude loading conditions

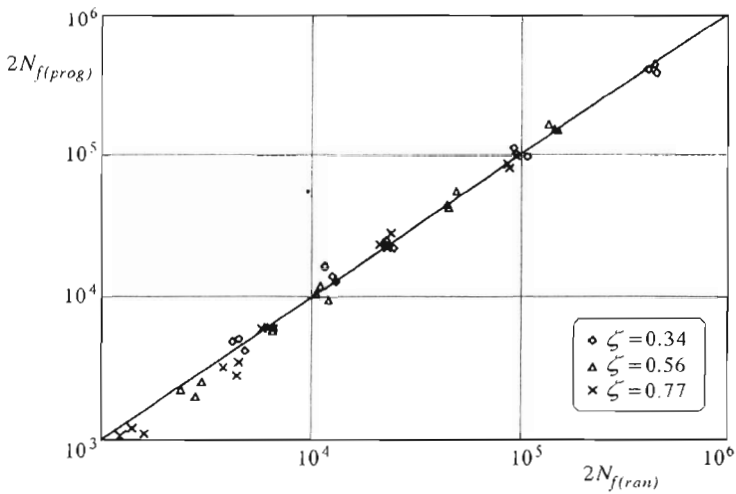

Fig. 6. Fatigue life of 45 steel under random and programmed loading conditions

during realisation of the programmed loading. The points under the diagonal line indicate the increase in the fatigue life of specimens during realisation of the random loading program.

### 5. Verification of the fatigue damage cumulative method

Using a special computer program calculations of the fatigue life were made on the assumptions accepted in Section 2. Verification was performed for all the loading program sequences applied.

Additionally, in order to estimate the presented method there was performed verification of the LDR. The calculation results obtained have been arranged in the form of respective quotients  $a = N_{cal}/N_{exp}$  in Table 2 (see also Fig.7).

**Table 2.** Calculation and test results of the fatigue life

$\zeta$	$\varepsilon_{ac\max}$	$a = N_{f(cal)}/N_{f(exp)}$			
		Random loading		Programmed loading	
		LDR	Present model	LDR	Present model
1	2	3	4	5	6
0.34	0.35	1.34	0.79	1.34	1.37
	0.5	1.35	0.87	1.35	1.52
	0.8	1.07	1.17	1.07	1.24
	1.0	1.02	0.97	1.02	1.15
	1.5	0.85	0.91	0.85	0.96
0.56	0.35	1.10	0.88	1.10	1.28
	0.5	0.89	0.87	0.89	1.02
	0.8	0.76	0.88	0.76	0.88
	1.0	0.70	0.76	0.70	0.80
	1.5	0.53	0.69	0.53	0.61
0.77	0.35	0.72	0.81	0.72	0.86
	0.5	0.80	0.81	0.80	0.92
	0.8	0.66	0.75	0.66	0.76
	1.0	0.50	0.76	0.50	0.60
	1.5	0.52	0.76	0.52	0.61

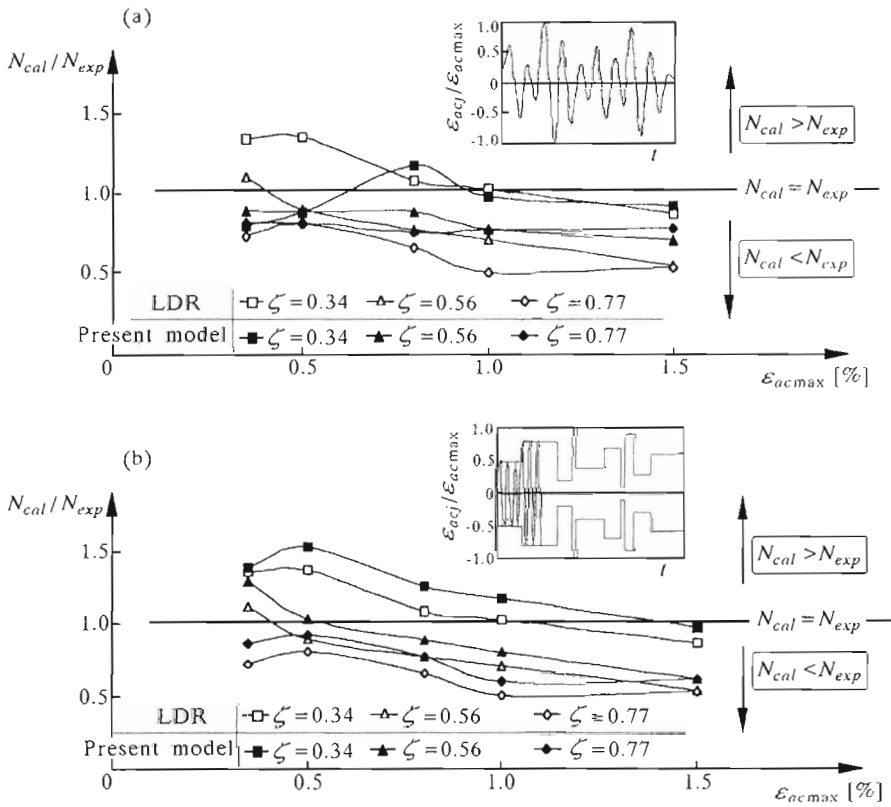

Fig. 7. Results of fatigue life calculation and test results under random and programmed loading conditions

### 6. Analysis of the results and conclusions

Basing on the analysis of fatigue test results obtained for two types of loading program it can be concluded that there arise insignificant differences between them. The fact that a majority of points in Fig.5 are located on the diagonal line or in its close vicinity evidently supports the above statement. Apparent differences in the fatigue life are purely accidental and basing on them one can hardly draw any conclusions about the effect of loading program on the fatigue life. It confirms also a possibility of replacing the service loading (random loading) with equivalent programmed loading.

An analysis of the ratio  $N_{f(cal)}/N_{f(exp)}$  obtained under the proposed hypothesis shows that its variations depend on the form of loading program and its parameters.

A majority of the calculation results obtained using this method were located in a safe area of fatigue life ( $N_{f(cal)} < N_{f(exp)}$ ). A better agreement between the test and calculation results appears rather under the random loading ( $0.69 < a < 1.17$ ) than under the programmed one ( $0.61 < a < 1.52$ ). The worst agreement between the calculation and test results using the proposed method for both types of loading programs can be observed for a sequence of programs with the coefficient of spectrum density  $\zeta = 0.34$ .

Variations of the values of  $N_{f(cal)}/N_{f(exp)}$  ratio in columns 4 and 6 prove that the hypothesis is sensitive to the type of loading program. That fact is of great practical importance. It enables one to use the presented hypothesis for predicting the fatigue life of structural parts under service loading.

Comparative analysis between the values of parameter  $a$  (Table 2) for the proposed damage accumulation methods and the LDR shows that only in the case of loading programs with coefficient  $\zeta = 0.34$  calculation error for proposed method is significantly higher than for the LDR method. In other cases of loading programs the obtained experimental and calculation results for verified hypotheses are in a comparable agreement.

The most important advantages of the method, which can be concluded from the performed analysis of calculation results, are as follows:

- Possibility for which using it for fatigue life calculations of structural parts made of the materials low-cycle properties as well as the loading program are known
- Sensitivity of the hypothesis to the type of loading program and its parameters (during computer simulations there was observed the sensitivity of hypothesis to the number of cycles in the block and the changes of sequence of levels in the program)
- Location of the calculation results in safe area of fatigue life ( $N_{f(cal)} < N_{f(exp)}$ ).

The advantages of the method were confirmed for one material used in the tests, e.g. 45-steel, which is characterised by stability of cyclic properties. In order to generalise the range of application of the presented calculation method the verification is necessary for materials in which evident cyclic hardening and softening phenomena are observed.

#### *Acknowledgement*

The work presented was supported financially by the State Committee for Scientific Research (KBN) under Grant No. 7T07A03508, which is gratefully acknowledged.

## References

1. ASTM E606-92: Standard Practice for Strain – Controlled Fatigue Testing
2. COLINS J. A., 1993, *Failure of Materials in Mechanical Design Analysis, Prediction, Prevention*, A Wiley – Interscience publication, New York, Second Edition
3. CORTEN H. T., DOLAN T. L., 1956, *Cumulative Fatigue Damage International Conference on Fatigue of Metals*, London
4. ELLYIN F., KUJAWSKI D., 1984, Plastic Strain Energy in Fatigue Failure, *J. Pressure Vessel Technology, Trans. ASME*, **106**, 342-347
5. GOŁOŚ K., ELLYIN F., 1987, Generalisation of Cumulative Damage Criterion to Multilevel Cyclic Loading, *Theoretical and Applied Fracture Mechanics*, **7**, 169-176
6. HAIBACH E., 1970, Modifizierte Lineare Schadensakkumulations - Hypothese zur Berücksichtigung, Laboratorium für Betriebsfestigkeit, Darmstad, *Technische Mitteilungen TM*, **50/70**
7. HASHIN Z., ROTEM A., 1978, Cumulative Damage Theory of Fatigue Failure, *Mater. Science and Engineering*, **34**, 2, 147-160
8. KUJAWSKI D., ELLYIN F., 1984, A Cumulative Damage Theory for Fatigue Crack Initiation and Propagation, *International J. Fatigue*, **6**, 2, 83-88
9. MANSSON S. S., HALFORD G. R., 1986, Re-Examination of Cumulative Fatigue Damage Analysis – an Engineering Perspective, *Engineering Fracture Mechanics*, **25**, 5/6
10. MINER M. A., 1945, Cumulative Damage in Fatigue, *J. Appl. Mech.*, **67**, A159-A164
11. MORROW J. D., 1965, Internal Friction, Damping and Cyclic Plasticity: Cyclic Plastic Strain Energy and Fatigue of Metals, *ASTM STP*, **378**, Philadelphia
12. PALMGREN A., 1924, Die Lebensdauer von Kugellagern, *Verfahrenstechnik*, Berlin, **68**, 339-341
13. SCHOTT G., 1981, Lebensdauerberechnung für Schwingbelastungen auf der Grundlage von Folgenwöhlerkurven, *Maschinenbautechnik*, **7**
14. SCHOTT G., 1983, *Razchety na prochnost pri peremennom nagruzkie na osnove vtorchnykh krivykh ustalosti*, Naukova Dumka, Kiev
15. SERENSEN S. V., KOGAEV V. P., 1966, Dolgovechnost detalei mashin s uchedom veroyatnosti rozrusheniya pri nestacyonarnom peremennom nagruzzhenii, *Vestnik Mashinostroeniya*, **1**
16. SUBRAMANYAN S., 1976, A Cumulative Damage Rule Based on the Knee Point of the S-N Curve, *Transaction of the ASME, Journal of Engineering Materials and Technology*, **A**, 316-321

17. SZALA J., 1981, Accumulation of Fatigue Damage in Random and Programmed Stress Conditions, *Archive of Mechanical Engineering*, **XXVIII**, 4 (in Polish)
18. TUCKER L.E., 1972, A Procedure for Designing Against Fatigue Failure of Notched Parts of Automative Engineers. Inc., *SAE Paper*, 720265, New York
19. WALLGREN G., 1949, Fatigue Tests with Cycles of Varying Amplitude, *FFA*, **28**

### Hipoteza kumulacji uszkodzeń zmęczeniowych w obszarze niskocyklowego zmęczenia

#### Streszczenie

W pracy przedstawiono propozycję metody sumowania uszkodzeń zmęczeniowych w obszarze niskocyklowego zmęczenia. Opisywana metoda jest oparta na koncepcji obrotu wykresu zmęczeniowego. Wykresem bazowym jest wykres trwałości zmęczeniowej w układzie współrzędnych  $\epsilon_{ac} - 2N_f$ . Niezbędne dane do obliczeń trwałości to własności niskocyklowe oraz parametry programu obciążenia.

Weryfikacja doświadczalna proponowanej hipotezy (jeden materiał, dwa rodzaje obciążenia – losowe i programowane) wykazała zadowalającą zgodność wyników obliczeń i badań. Przeprowadzona analiza porównawcza wyników obliczeń uzyskanych przy wykorzystaniu hipotezy liniowej (LDR) oraz hipotezy przedstawionej w poniższej pracy wykazała szereg zalet tej ostatniej. Do zalet metody obliczeń zaliczono m.in. położenie uzyskanych wyników obliczeń w bezpiecznym obszarze trwałości, jej prostotę, oraz wrażliwość na parametry programu obciążenia.

*Manuscript received April 26, 1999; accepted for print December 9, 1999*