

## ROBUST CONTROL DESIGN OF A SMART BUILDING STRUCTURE

DANIELA G. MARINOVA

*Department of Applied Mathematics and Informatics, Technical University of Sofia, Bulgaria  
e-mail: dmarinova@dir.bg*

GEORGIOS E. STAVROULAKIS

*Department of Production Engineering and Management, Technical University of Crete, Greece;  
Department of Civil Engineering, Technical University of Braunschweig, Germany  
e-mail: gstavr@dpem.tuc.gr*

This paper presents an application of a design method of robust  $H_\infty$  optimal control to a structural control system. A dynamic model for a building structure under earthquake and wind excitations is considered. Structured uncertainties are introduced to reflect errors between the model and the reality. To obtain the best possible performance in the face of uncertainties, robust  $H_\infty$  optimal control for the active control structure is used. Relevant numerical techniques, which have been implemented with the help of MATLAB routines, are applied to solve the formulated structural control problem. By proper selection of the weight factor, the seismic response of the building structure can be reduced considerably. Numerical results show high robust performance of the proposed method.

*Key words:* robust control, structural control, applied optimization, uncertainty system

### 1. Introduction

The control of structural vibrations is an important goal for the structural engineer. Several control techniques have been developed for these purposes. Classical engineering design based on appropriate choice of materials and of dimensions of the structure provides only a partial solution to the problem because of their limited control action. Active control is an interesting alternative (Housner and Bergman, 1997). The ideas of integrating the automatic

control concept or installing a mechanical control device into the seismic structural design were proposed more than forty years ago (Kobori, 1956; Kobori and Minai, 1960). In an active control system, an external source powers actuators that apply forces to the structure in a prescribed manner. The design objectives are to keep the outputs (displacements, accelerations, stresses and strains) at a specified set of locations within the structure below specified bounds in the presence of any disturbances less than a certain size. The most commonly used active control method in structures is the feedback control. The control strategy can be chosen in an optimal way. The linear quadratic optimal control (LQR) has been the control strategy considered in most published examinations (Marinova and Stavroulakis, 2002). Linearity of such a controller and the phase margin theoretically provided by this technique are the main reasons for this choice. However, the LQR technique does not address practical issues such as model uncertainties. Modern control principles as  $H_2$  and  $H_\infty$  theories can be used to feed back information to the control system with controllability and sensing ability dealing with uncertainties.

The active control strategy for the enhancement of structural safety will play a more important role along with more integration of the computer based control technology. In this respect, not a few problems must be solved. One of these important problems is the robustness of active control systems. The  $H_\infty$  control strategy is one of these computer based approaches that is able to ensure the robustness of a system. The  $H_\infty$  theory has been applied to a number of civil engineering structures (Jabbari *et al.*, 1995; Smith and Chase, 1994; Suhardjo *et al.*, 1992; Zacharenakis, 1997; Arvanitis *et al.*, 2003). The earliest use in the civil engineering context appears to be due to Suhardjo and Spencer, who also provided a comparison between the  $H_2$  and  $H_\infty$  approaches (Suhardjo *et al.*, 1992). The  $H_\infty$  design technique (Zhou, 1998) provides better robustness than the LQG or  $H_2$  method. The implementation of the  $H_\infty$  control theory is motivated by the inability of the LQG/ $H_2$  theory to directly accommodate plant uncertainties.

A dynamical model of a smart building structure under external excitations is considered in this paper. It is well known that the nominal model parameters are determined by material properties and geometry configuration, but physical parameters of a real structure system are not known exactly. The external influences acting on the system lead to errors in tracking. Parameter perturbations in the system can significantly amplify the effect of these disturbances. Thus, the appearance of model parameter uncertainties is a common task in the building structure control. Two kinds of uncertainties can be considered: unstructured and structured. For several reasons, it is highly desirable to introduce structured uncertainties for physical parameters of the system.

The aim of this research is to design a robust controller to suppress adverse vibrations of building structures due to earthquake and wind excitations in

presence of structured uncertainties of the physical parameters introduced to compensate for the inaccuracies of the considered dynamical model. To obtain the best possible performance in the face of the uncertainties, a robust  $H_\infty$  optimal control for active control structures is considered. The design specifications of  $H_\infty$  control are given in the frequency domain, and thus it is easy for  $H_\infty$  control to deal with the uncertainty at high frequencies and to guarantee the robust stability and robust performance. Relevant numerical techniques, which have been implemented with the help of MATLAB routines, are applied to solve the formulated structural control problem. The numerical computation carried out on a one-story building structure shows that by a proper selection of the weight factor vibration of the system due to external impacts can be considerably suppressed with the designed  $H_\infty$  control.

## 2. Governing relations

In the present work, a dynamic model of a building structure under external dynamical excitations is studied. The structure is designed by a certain number of members. Some members are supplied with actuators. The actively controlled members help to reduce large displacements and stresses resulting from dynamic loadings. Forces produced by the controllers reduce the structure response by producing an opposite effect to the structure response. After finite element discretization, the following differential equations govern the dynamics of the model

$$\bar{\mathbf{M}}\ddot{\mathbf{X}}(t) + \bar{\mathbf{C}}\dot{\mathbf{X}}(t) + \bar{\mathbf{E}}\mathbf{X}(t) = \mathbf{H}\mathbf{u}(t) + \mathbf{F}(t) \quad (2.1)$$

where the vector  $\mathbf{X}(t)$  describes the displacements and the vector  $\mathbf{u}(t)$  contains the control forces.  $\bar{\mathbf{M}}$ ,  $\bar{\mathbf{C}}$  and  $\bar{\mathbf{E}}$  are the nominal mass, damping and stiffness matrices, respectively,  $\mathbf{H}$  is the distribution matrix defining the locations of control forces and  $\mathbf{F}(t)$  is the external loading vector. All matrices with appropriate dimensions are constant and real. Mathematical model (2.1) provides a mapping from the inputs to the responses. Suppose that sensors measuring the displacements of the structure are assembled to all members. Let then introduce an output vector

$$\mathbf{y} = \mathbf{X}(t) \quad (2.2)$$

consisting of measures formed from the state vector  $\mathbf{X}(t)$ . Equations (2.1)-(2.2) constitute the nominal plant representation in a state space form.

The inputs of dynamical system (2.1)-(2.2) are  $\mathbf{x} = [\mathbf{X}(t), \dot{\mathbf{X}}(t)]^\top$ ,  $\mathbf{u}(t)$  and  $\mathbf{F}(t)$ , and the outputs are  $\mathbf{y} = \mathbf{x}$ . System (2.1)-(2.2) gets the form

$$\begin{bmatrix} \dot{\mathbf{x}} \\ \mathbf{y} \end{bmatrix} = \mathbf{G}_n \begin{bmatrix} \mathbf{x} \\ \mathbf{u} \end{bmatrix} \quad (2.3)$$

where  $\mathbf{G}_n$  is the nominal plant

$$\begin{aligned} \mathbf{G}_n &= \begin{bmatrix} \mathbf{A} & \mathbf{B}_2 \\ \mathbf{C}_2 & \mathbf{D}_{22} \end{bmatrix} & \mathbf{A} &= \begin{bmatrix} \mathbf{0} & \mathbf{I} \\ -\overline{\mathbf{M}}^{-1}\overline{\mathbf{E}} & -\overline{\mathbf{M}}^{-1}\overline{\mathbf{C}} \end{bmatrix} \\ \mathbf{B}_2 &= \begin{bmatrix} \mathbf{0} \\ -\overline{\mathbf{M}}^{-1}\mathbf{H} \end{bmatrix} & \mathbf{C}_2 &= [\mathbf{I} \quad \mathbf{0}] & \mathbf{D}_{22} &= \mathbf{0} \end{aligned}$$

where  $\mathbf{I} = \mathbf{I}_{n \times n}$  is the identity matrix. The quality of model (2.3) depends on how closely its responses match those of the true plant.

### 3. Model uncertainty

The term "uncertainty" reflects the differences of errors between the model and the reality. Because the building structure is built from components that are themselves uncertain, then the uncertainty in the system level is structured. The variations in the structure system are approximated by disk shaped regions on the real axis leading to a multiplicative uncertainty description of the bounds. Let suppose that the three actual physical parameters  $\mathbf{M}$ ,  $\mathbf{C}$ , and  $\mathbf{E}$  are not exactly known, but are believed to lie in known intervals. In particular, the actual mass  $\mathbf{M}$  is within  $p_M$  percentages of the nominal mass  $\overline{\mathbf{M}}$ , the actual damping value  $\mathbf{C}$  is within  $p_C$  percentages of the nominal value  $\overline{\mathbf{C}}$ , and the spring stiffness  $\mathbf{E}$  is within  $p_E$  percentages of its nominal value of  $\overline{\mathbf{E}}$ . The nominal matrices  $\overline{\mathbf{M}}$ ,  $\overline{\mathbf{C}}$ ,  $\overline{\mathbf{E}}$  are assumed to be diagonal. Now, by introducing real perturbations in a diagonal form

$$\Delta_M = \delta_M \mathbf{I} \quad \Delta_C = \delta_C \mathbf{I} \quad \Delta_E = \delta_E \mathbf{I} \quad (3.1)$$

which are assumed to be unknown but restricted

$$-1 \leq \delta_M, \delta_C, \delta_E \leq 1 \quad (3.2)$$

we can write the actual physical parameters of the system in the following form

$$\begin{aligned} \mathbf{M} &= \overline{\mathbf{M}}(\mathbf{I} + p_M \Delta_M) & \mathbf{C} &= \overline{\mathbf{C}}(\mathbf{I} + p_C \Delta_C) \\ \mathbf{E} &= \overline{\mathbf{E}}(\mathbf{I} + p_E \Delta_E) \end{aligned} \quad (3.3)$$

The uncertainty in the matrices  $\mathbf{M}^{-1}$ ,  $\mathbf{C}$  and  $\mathbf{E}$  can be represented by Linear Fractional Transformations (LFT) of the matrix functions as the upper LTF in the perturbations  $\Delta_M$ ,  $\Delta_C$  and  $\Delta_E$  (Zacharenakis, 1977)

$$\mathbf{M}^{-1} = \mathbf{F}_U \left( \begin{bmatrix} -p_M \mathbf{I} & \bar{\mathbf{M}}^{-1} \\ -p_M \mathbf{I} & \bar{\mathbf{M}}^{-1} \end{bmatrix}, \Delta_M \right) \quad \mathbf{C} = \mathbf{F}_U \left( \begin{bmatrix} 0 & \bar{\mathbf{C}} \\ p_C \mathbf{I} & \bar{\mathbf{C}} \end{bmatrix}, \Delta_C \right) \quad (3.4)$$

$$\mathbf{E} = \mathbf{F}_U \left( \begin{bmatrix} 0 & \bar{\mathbf{E}} \\ p_E \mathbf{I} & \bar{\mathbf{E}} \end{bmatrix}, \Delta_E \right)$$

Thus, the considered control design problem will be formulated in a LFT frame-work. A useful interpretation of the LFT is the following. The LFT in (3.4) have a nominal mapping (first terms in the first rows in the matrices) that are perturbed by  $\Delta_M$ ,  $\Delta_C$ ,  $\Delta_E$  while the other terms of the matrices reflect prior knowledge as how the perturbations affect the nominal mappings. This is why the LFT is particularly useful in the study of perturbations, which are in the focus of this paper. Then a block diagram of system (2.3) can be arranged to look like the one in Fig. 1 with reflected perturbations of the parameters.

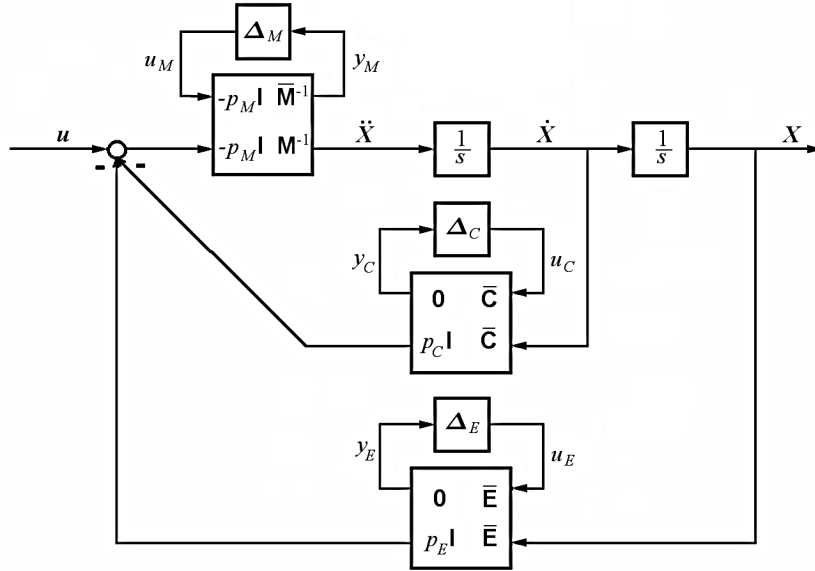

Fig. 1. Block diagram for system with uncertain parameters

To represent the model as a LFT of the natural uncertainty parameters  $\delta_M$ ,  $\delta_C$ ,  $\delta_E$ , we first isolate the uncertainty parameters and denote the inputs of  $\Delta_M$ ,  $\Delta_C$ ,  $\Delta_E$  as  $y_M$ ,  $y_C$ ,  $y_E$  and their outputs as  $u_M$ ,  $u_C$ ,  $u_E$ . The outputs

$\mathbf{u}_\Delta = [u_M, u_C, u_E]$  from the perturbations are added to the system inputs. The inputs  $\mathbf{y}_\Delta = [y_M, y_C, y_E]$  to the perturbations are added to the system outputs. The model for the uncertain system is obtained in the following matrix form

$$\begin{bmatrix} \dot{\mathbf{x}} \\ \mathbf{y}_\Delta \\ \mathbf{y} \end{bmatrix} = \mathbf{G} \begin{bmatrix} \mathbf{x} \\ \mathbf{u}_\Delta \\ \mathbf{u} \end{bmatrix} \quad \mathbf{u}_\Delta = \mathbf{\Delta} \mathbf{y}_\Delta \quad (3.5)$$

where  $\mathbf{G}$  is the plant of the perturbed system

$$\begin{aligned} \mathbf{G} &= \begin{bmatrix} \mathbf{A} & \mathbf{B}_1 & \mathbf{B}_2 \\ \mathbf{C}_1 & \mathbf{D}_{11} & \mathbf{D}_{12} \\ \mathbf{C}_2 & \mathbf{D}_{21} & \mathbf{D}_{22} \end{bmatrix} & \mathbf{B}_1 &= \begin{bmatrix} \mathbf{0} & \mathbf{0} & \mathbf{0} \\ -p_M \mathbf{I} & -p_C \overline{\mathbf{M}}^{-1} & -p_E \overline{\mathbf{M}}^{-1} \end{bmatrix} \\ \mathbf{C}_1 &= \begin{bmatrix} -\overline{\mathbf{M}}^{-1} \overline{\mathbf{E}} & -\overline{\mathbf{M}}^{-1} \overline{\mathbf{C}} \\ \mathbf{0} & \overline{\mathbf{C}} \\ \overline{\mathbf{E}} & \mathbf{0} \end{bmatrix} & \mathbf{D}_{11} &= \begin{bmatrix} -p_M \mathbf{I} & -p_C \overline{\mathbf{M}}^{-1} & -p_E \overline{\mathbf{M}}^{-1} \\ \mathbf{0} & \mathbf{0} & \mathbf{0} \\ \mathbf{0} & \mathbf{0} & \mathbf{0} \end{bmatrix} \\ \mathbf{D}_{12} &= \begin{bmatrix} \overline{\mathbf{M}}^{-1} \mathbf{H} \\ \mathbf{0} \\ \mathbf{0} \end{bmatrix} & \mathbf{D}_{21} &= \begin{bmatrix} \mathbf{0} & \mathbf{0} & \mathbf{0} \end{bmatrix} \end{aligned} \quad (3.6)$$

The matrix  $\mathbf{G}$  in (3.5) contains only physical nominal parameters of the system and, therefore, it is known. The system model uncertainty matrix in (3.5), denoted by  $\mathbf{\Delta}$ , is a structural matrix

$$\mathbf{\Delta} = \begin{bmatrix} \Delta_M & \mathbf{0} & \mathbf{0} \\ \mathbf{0} & \Delta_C & \mathbf{0} \\ \mathbf{0} & \mathbf{0} & \Delta_E \end{bmatrix}$$

It has a block diagonal structure and affects the input/output relation between the control  $\mathbf{u}$  and the output  $\mathbf{y}$  in a way that it can be represented as a feedback by the upper LFT

$$\mathbf{y} = \mathbf{F}_U(\mathbf{G}, \mathbf{\Delta}) \mathbf{u} \quad (3.7)$$

#### 4. Feedback properties

Further we will discuss how to achieve the desired performance using feedback control in the face of uncertainties. Consider the feedback system with the plant  $\mathbf{G}$  and controller  $\mathbf{K}$ .

Let  $\mathbf{r}$  be the command input that the system must be able to track;  $\mathbf{d}$  the disturbance input that the system must be able to reject;  $n$  the sensor noise;

$\mathbf{y}$  the total output of the closed loop system that has to be controlled;  $\mathbf{u}$  the control signal and  $\mathbf{K}$  – the controller. We have the following equations for the output and control in the frequency domain (Zacharenakis, 1997)

$$\begin{aligned}\mathbf{y}(s) &= \mathbf{T}(s)\mathbf{r}(s) + \mathbf{S}(s)\mathbf{d}(s) - \mathbf{T}(s)\mathbf{n}(s) \\ \mathbf{u}(s) &= \mathbf{K}(s)\mathbf{S}(s)[\mathbf{r}(s) - \mathbf{n}(s) - \mathbf{d}(s)]\end{aligned}\tag{4.1}$$

where  $\mathbf{S}(s) = (\mathbf{I} + \mathbf{G}\mathbf{K})^{-1}$  is the sensitivity and  $\mathbf{T}(s) = \mathbf{G}\mathbf{K}(\mathbf{I} + \mathbf{G}\mathbf{K})^{-1}$  is the complementary sensitivity transfer matrix. From equations (4.1) and the obvious equation  $\mathbf{S}(s) + \mathbf{T}(s) = \mathbf{I}$  there follow the main design objectives inherent in the feedback loop. In a norm sense,  $\mathbf{S}(s)$  must be small at low frequencies for good disturbance rejection and must increase to one at high frequencies, whereas  $\mathbf{T}(s)$  must be one at low frequencies and get smaller at high frequencies for good noise suppression. Intermediate frequencies typically control the gain and phase margins.

## 5. Robust stability and robust performance

Consider the perturbed system with a set of perturbed models described by the system matrix  $\mathbf{G}$ . The performance criterion is to keep the errors as small as possible in some sense for all perturbed models. The performance specifications will be specified in some requirements on the closed loop frequency response of the transfer matrix between the disturbances and the errors which lead to the  $H_\infty$  design framework. In this section, we focus on the  $H_\infty$  performance objectives.

The robust stability and robust performance criteria vary with the assumptions about uncertainty descriptions and performance requirements. They will be treated in a unified framework using the LFT and the Structured Singular Value (SSV)  $\mu$ . Such a unified approach relieves the mathematical burden of dealing with specific problems, and enables us to treat the robust stability and robust performance problems for systems with multiple sources of uncertainties in the same fashion as a single unstructured uncertainty. For simplification, we shall cover the real parametric uncertainty with a norm-bounded dynamical uncertainty.

For the robust stability analysis, the controller  $\mathbf{K}$  can be viewed as a known system component and absorbed into an interconnection structure  $\mathbf{P}$  together with the plant  $\mathbf{G}$ . The interconnection model  $\mathbf{P}$  can always be chosen so that  $\Delta(s)$  is block diagonal. According to the Nyquist criterion, if the matrices  $\mathbf{P}$  and  $\Delta$  are stable then the interconnection system is stable if and only if

$\det(\mathbf{I} - \mathbf{P}\Delta) \neq 0$ . For the robust stability, we are interested in finding the smallest perturbation  $\Delta$  real and norm bounded  $\|\Delta\|_\infty < 1$  in the sense of the maximal singular value  $\bar{\sigma}(\Delta)$  (that is ensured with equations (3.1) and (3.2)) such that the closed loop framework will be stabilized, i.e.

$$\det(\mathbf{I} - \mathbf{P}\Delta) = 0 \quad (5.1)$$

The exact stability and performance analysis for the system with structured uncertainty requires the matrix function SSV to be defined as

$$\mu_\Delta(\mathbf{P}) = \frac{1}{\min\{\bar{\sigma}(\Delta) : \Delta \in D, \det(\mathbf{I} - \mathbf{P}\Delta) = 0\}} \quad (5.2)$$

It can be shown that the SSV is bounded as follows

$$\rho(\mathbf{P}) \leq \mu_\Delta(\mathbf{P}) \leq \bar{\sigma}(\mathbf{P}) \quad (5.3)$$

where  $\rho(\mathbf{P})$  is the spectral radius and  $\bar{\sigma}(\mathbf{P})$  is the maximal singular value of the matrix  $\mathbf{P}$ . The loop is well-posed and internally stable for all  $\Delta$  with  $\|\Delta\|_\infty < 1$  if and only if

$$\sup_{\omega \in R} \mu_\Delta(\mathbf{P}(j\omega)) < 1 \quad (5.4)$$

Hence, the peak value on the  $mu_\Delta$  plot of the frequency response determines the size of the perturbations for which the loop is robustly stable against. The quantity

$$\frac{1}{\max_\omega \mu_\Delta[\mathbf{P}(j\omega)]} \quad (5.5)$$

is a stock of stability with respect to  $\mathbf{P}$  influenced by the structured uncertainty.

The external influences acting on the system lead to errors in tracking. Parameter perturbations in the system can significantly amplify the effect of these disturbances. As a result, the performance of the closed loop system can be deteriorated before the stability is lost. That is why we must ensure robust performance regarding the given level of perturbations.

The system performance criterion is the  $H_\infty$  norm of some transfer matrix of the system that is to be less than one. In the case of a system with an uncertainty, a convenient characteristic for the robust performance is the sensitivity or complementary sensitivity transfer matrix (or their combination) from the external disturbances  $\mathbf{d}$  to the errors  $\mathbf{e}$ . It is a function of  $\Delta$  through the elements of the matrix  $\mathbf{P}$  and the LFT. The LFT  $\mathbf{F}_U(\mathbf{P}, \Delta)$  achieves a good performance if it is stable for all admissible  $\Delta$  satisfying  $\max_\omega \bar{\sigma}[\Delta(j\omega)] < 1$ , and if  $\|\mathbf{F}_U(\mathbf{P}, \Delta)\|_\infty \leq 1$  for all such perturbations. Using the Nyquist criterion and the theorem for the small amplifying coefficient, it can be shown that



$\|\mathbf{F}_U(\mathbf{P}, \Delta)\|_\infty \leq 1$  if and only if the loop is stable for any  $\Delta_F$  and for any  $\Delta$  such that  $\max_\omega \bar{\sigma}[\Delta(j\omega)] < 1$  and  $\max_\omega \bar{\sigma}[\Delta_F(j\omega)] < 1$ . But this is the robust stability problem for  $\mathbf{P}$  with the perturbation

$$\Delta_P = \begin{bmatrix} \Delta & \mathbf{0} \\ \mathbf{0} & \Delta_F \end{bmatrix} \quad (5.6)$$

Hence, we determine the robust stability for an augmented system using an additional uncertainty element and calculating  $\mu_{\Delta_P}[\mathbf{P}(j\omega)]$  to make conclusions for the robust performance of the initial system with the uncertainty  $\mathbf{F}_U(\mathbf{P}, \Delta)$ .

For our purposes, we take the sensitivity transfer matrix of the closed loop system as a performance criterion and we will require for its norm the following inequality

$$\|\mathbf{W}_p(\mathbf{I} + \mathbf{GK})^{-1}\|_\infty < 1 \quad (5.7)$$

to achieve the desirable performance. This requirement must be satisfied for a given weight matrix  $\mathbf{W}_p$  such that to reject the disturbances for low frequencies at the output. The performance weight matrix  $\mathbf{W}_p$  can be chosen in a diagonal form

$$\mathbf{W}_p(s) = w_p(s)\mathbf{I} \quad (5.8)$$

The inequality (5.7) with assumption (5.8) implies that the maximal singular value of the sensitivity transfer matrix must satisfy the inequality

$$\bar{\sigma}[(\mathbf{I} + \mathbf{GK})^{-1}(j\omega)] < \left| \frac{1}{w_p(j\omega)} \right| \quad (5.9)$$

## 6. Formulation of the $H_\infty$ control problem

Let us present the considered uncertain system defined by equation (3.5) by a two block diagram shown in Fig. 2, where the input  $\mathbf{w} = [\mathbf{u}_\Delta, \mathbf{d}]^\top$  includes all signals coming to the system and the error  $\mathbf{z} = [\mathbf{y}_\Delta, \mathbf{e}]^\top$  includes all signals characterising the system response. Therefore, system (3.5) can be represented in terms of frequency by the equation

$$\begin{bmatrix} \mathbf{z} \\ \mathbf{y} \end{bmatrix} = \mathbf{G} \begin{bmatrix} \mathbf{w} \\ \mathbf{u} \end{bmatrix} \quad (6.1)$$

The aim of this Section is to design an admissible controller  $\mathbf{K}$

$$\mathbf{u} = \mathbf{K}\mathbf{y} \quad (6.2)$$

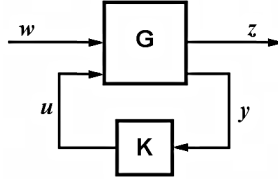
Fig. 2. General framework for  $H_\infty$  control problem

which internally stabilizes system (6.1) and minimizes the  $H_\infty$  norm of the closed loop transfer matrix from  $w$  to  $z$ . The closed loop transfer matrix of system (6.1) from  $w$  to  $z$  is given as the lower LFT in  $\mathbf{K}$

$$z = \mathbf{F}_L(\mathbf{G}, \mathbf{K})w$$

Then the optimal  $H_\infty$  control design problem can be formulated by the equation

$$\|\mathbf{F}_L(\mathbf{G}, \mathbf{K})\|_\infty = \max_{\omega} \bar{\sigma}(\mathbf{F}_L(\mathbf{G}, \mathbf{K})(j\omega)) \rightarrow \min \quad (6.3)$$

The transfer matrix  $\mathbf{F}_L(\mathbf{G}, \mathbf{K})$  contains measures of the nominal performance and stability robustness. Its  $H_\infty$  norm gives a measure of the worst response of the system over the entire class of input disturbances. The optimal  $H_\infty$  controller, as just defined, is not unique for our MIMO system (in contrast with the standard  $H_2$  theory, in which the optimal controller is unique). The knowledge of the optimal  $H_\infty$  norm is useful theoretically, since it sets a limit on what we can achieve. In practice, it is often not necessary to design an optimal controller, and it is much cheaper to obtain a controller that is close, in the norm sense, to the optimal one.

We consider below the suboptimal  $H_\infty$  control problem. For given  $\gamma > 0$ , find an admissible controller  $\mathbf{K}_{sub(s)}$  such that the  $H_\infty$  norm closed loop transfer matrix of system (6.1) from  $w$  to  $z$  is less than  $\gamma$

$$\|\mathbf{F}_L(\mathbf{G}, \mathbf{K}_{sub})\|_\infty < \gamma \quad (6.4)$$

On some assumptions for the plant  $\mathbf{G}$  (Zacharenakis, 1997), such a controller is

$$\mathbf{K}_{sub} = \begin{bmatrix} \mathbf{A}_\infty & -\mathbf{Z}_\infty \mathbf{L}_\infty \\ \mathbf{F}_\infty & \mathbf{0} \end{bmatrix} \quad (6.5)$$

where  $\mathbf{X}_\infty \geq \mathbf{0}$  and  $\mathbf{Y}_\infty \geq \mathbf{0}$  are solutions to the corresponding algebraic Riccati equations, and

$$\begin{aligned} \mathbf{A}_\infty &= \mathbf{A} + \gamma^{-2} \mathbf{B}_1 \mathbf{B}_1^\top \mathbf{X}_\infty + \mathbf{B}_2 \mathbf{F}_\infty + \mathbf{Z}_\infty \mathbf{L}_\infty \mathbf{C}_2 \\ \mathbf{F}_\infty &= -\mathbf{B}_2^\top \mathbf{X}_\infty & \mathbf{L}_\infty &= -\mathbf{Y}_\infty \mathbf{C}_2^\top \\ \mathbf{Z}_\infty &= (\mathbf{I} - \gamma^{-2} \mathbf{Y}_\infty \mathbf{X}_\infty)^{-1} \end{aligned}$$

## 7. Simulations and numerical results

For numerical simulations of the structure, a two-dimensional frame modeled by three finite elements (two vertical and one horizontal) is considered. The vertical elements are supposed to be cantilevered. The horizontal element is supplied with a controller and a sensor, which are placed at the same location and measure/control horizontal motion. Every element has two nodes and every node has three degrees of freedom: horizontal displacement, vertical displacement and rotation. The nominal physical parameters of the system are chosen as follows:  $\bar{m} = 3$ ,  $\bar{c} = 0.5$ ,  $olk = 2$ . The values that specify the intervals in which the real physical parameters lie are:  $p_M = 0.1$ ,  $p_C = 0.2$ ,  $p_K = 0.2$ . The frequency responses of the perturbed open loop system are presented in Fig. 3.

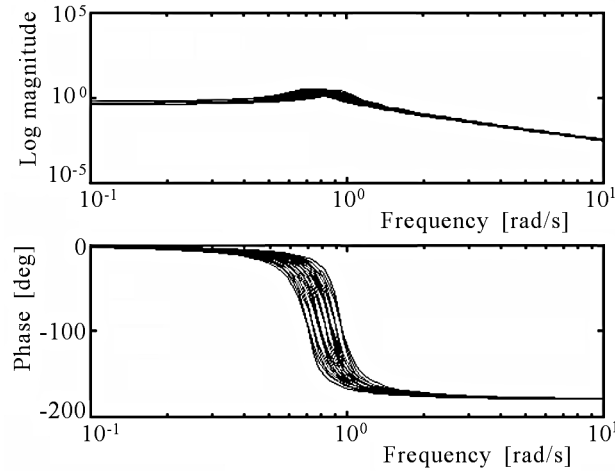

Fig. 3. Frequency response of perturbed open loop systems

The factor  $w_p$  of the performance weight matrix in equation (5.8) is chosen as

$$w_p(s) = \frac{s^2 + 2s + 10}{s^2 + 70s + 0.01} \quad (7.1)$$

which gives a good disturbance rejection and good transient response. At low frequencies, the closed loop system must reject the disturbance at the output with ratio 10 to 0.01. This performance requirement gets weaker in higher frequencies.

We design a control law that minimizes the  $H_\infty$  norm of  $\mathbf{F}_L(\mathbf{G}, \mathbf{K})$  in the transfer matrix of the controller.  $\mathbf{F}_L(\mathbf{G}, \mathbf{K})$  is the nominal transfer matrix of the closed loop system from the outputs  $\mathbf{u}_\Delta$  of the parametric perturbations and external disturbances to the inputs  $\mathbf{y}_\Delta$  of the parametric perturbations

and errors. For numerical calculations, the interval for the parameter  $\gamma$  in equation (6.2) is chosen as  $[1;20]$  with tolerance 0.002. After a number of iterations of consequent decreasing  $\gamma$  and checking if the suboptimal problem has a solution for the consecutive  $\gamma$ , we find that the minimal value for  $\gamma$  is 2.00. The suboptimal controller is obtained in the form

$$K_{sub}(s) = \frac{898s^3 + 62269s^2 - 8262s + 37705}{s^4 + 2340s^3 + 10823s^2 + 21838s + 4}$$

The frequency response of the sensitivity and complementary sensitivity transfer matrices of the closed loop system is shown in Fig. 4. Their shapes corroborate good feedback properties.

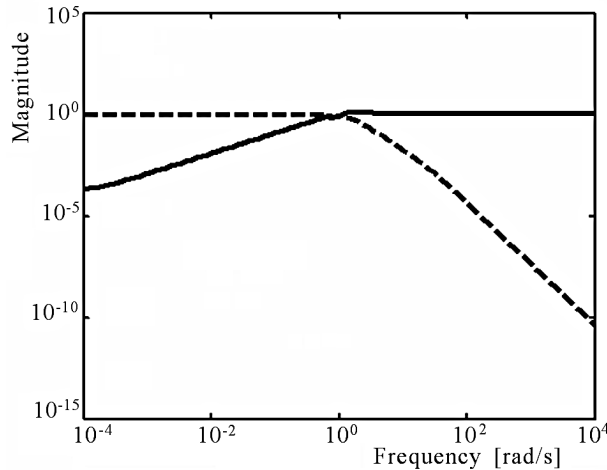

Fig. 4. Sensitivity (solid) and complementary sensitivity (dashed) transfer matrices

With MATLAB tools, in accordance with inequality (5.3), the upper and lower bounds of the SSV  $\mu_{\Delta}$  are calculated. The quantity  $\rho(\mathbf{P})$  can have multiple maxima that are not global. Thus, a local search cannot guarantee successful determination of  $\mu_{\Delta}$ , but can only yield the lower bound. The upper bound  $\bar{\sigma}(\mathbf{P})$  can be reformulated as a convex optimization problem, so the global minimum can be found. The upper bound is not always equal to  $\mu_{\Delta}$ . It depends on the structure of the uncertainty matrix  $\Delta$  (Zhou, 1998). For the considered system SSV, there exist matrices for which  $\mu_{\Delta}$  is less than the infimum of  $\bar{\sigma}(\mathbf{P})$ . Therefore, conclusions concerning the robust stability are drawn in terms of these bounds. Satisfying inequality (5.4) to achieve robust stability, the  $\mu_{\Delta}$  upper bound must be less than 1. The SSV  $\mu_{\Delta}$  is defined in equation (5.2) for cases with complex perturbations. The parametric perturbations in model (3.5) are considered to be real. The algorithm used here deals with robust analysis of systems with real and complex blocks in the

uncertainty matrix. For better convergence of the algorithm computing the  $\mu_{\Delta}$  lower bound, 1% complex perturbations are added. The frequency responses of the  $\mu_{\Delta}$  upper and lower bounds displayed in Fig. 11 show that the closed loop system with the  $H_{\infty}$  suboptimal controller achieves robust stability. The maximal value of  $\mu_{\Delta}$  is 0.965 and, therefore, the robust stability is possible for perturbations with the norm  $\|\Delta\|_{\infty} < 1/0.965$ . In Fig. 5 the frequency response of the maximal singular value of the transfer matrix characterizing the robust stability with respect to unstructured uncertainties is shown. This bound also achieves robust stability but gives pessimistic results with respect to the structured uncertainties.

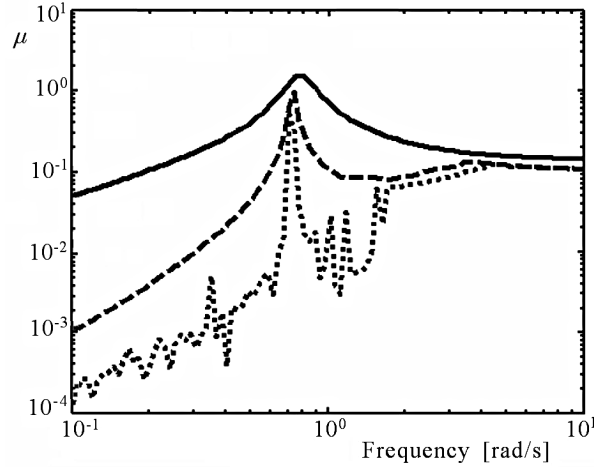

Fig. 5.  $\mu_{\Delta}$  upper bound (dashed),  $\mu_{\Delta}$  lower bound (dotted),  $H_{\infty}$  bound (solid)

Comparing the maximal singular value of the closed loop sensitivity transfer matrix with the inverse of the weight matrix, we observe that the magnitude of its maximal singular value satisfies inequality (5.9) and lies under the inverse of the performance weight matrix for any frequency, which indicates good robust performance with good disturbance rejection and transient response. The result is displayed in Fig. 6.

The nominal performance of the closed loop system with regard to the weight matrix of the performance is achieved if and only if the frequency response of the respective transfer matrices of the closed loop system with  $\mathbf{K}_{sub}$  is less than one. The upper inputs/outputs of the closed loop transfer matrix are linked by the perturbation  $\Delta$ , and the lower inputs/outputs correspond to the weight output sensitivity matrix. Therefore, the matrix  $\Delta$  in the matrix  $\Delta_P$  in equation (5.6) consists in the uncertainty block  $\Delta$  and the matrix  $\Delta_F$  in the performance block. The robust performance in the uncertainty and the weight performance matrix is achieved if and only if the SSV  $\mu_{\Delta_P}$

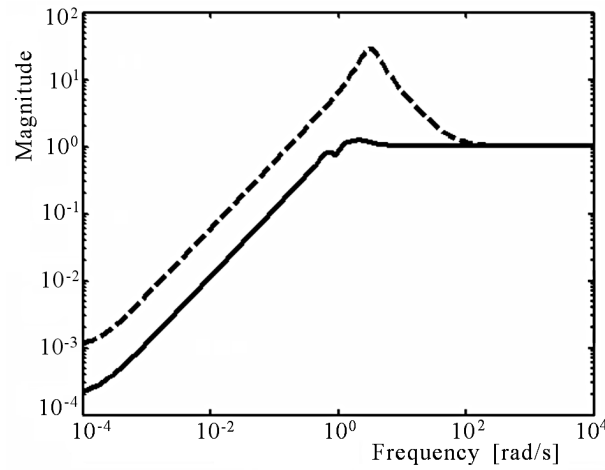

Fig. 6. Sensitivity transfer matrix for  $\mathbf{K}_{sub}$  (solid) and inverse weight matrix (dashed)

for the closed loop frequency response is less than one for all frequencies. The frequency responses of the nominal and robust performance are shown in Fig. 7. The maxima of the frequency responses on the nominal and robust performance are 0.204 and 1.082, respectively. Therefore, the system with the  $\mathbf{K}_{sub}$  controller achieves the nominal and robust performance. Concerning the robust performance means that there exists a matrix of perturbations  $\Delta_G$  such that  $\|\Delta_G\|_\infty = 1/1.082$  for which the norm of the perturbed weighted sensitivity matrix equals 1.082.

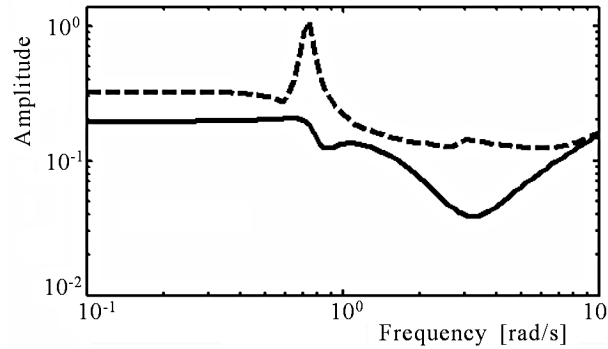

Fig. 7. Nominal (solid) and robust (dashed) performance for  $\mathbf{K}_{sub}$

To demonstrate the good closed loop transient response in tracking we supply the structure system with a periodic impulsive command input without an external loading. The time response to the reference is shown in Fig. 8. The good closed loop transient response in disturbance rejection due to periodic isolated influences is shown in Fig. 9.

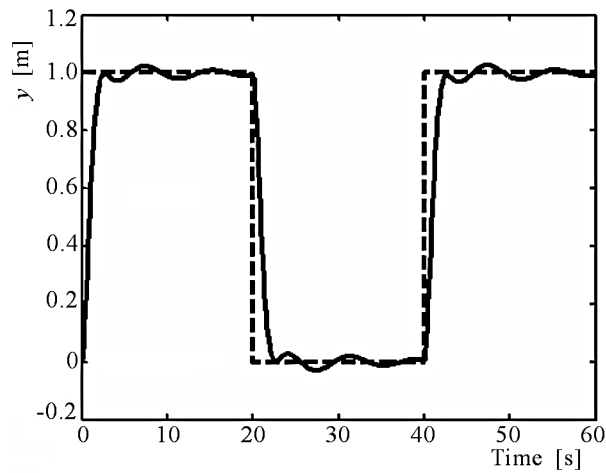

Fig. 8. Closed-loop time response in tracking

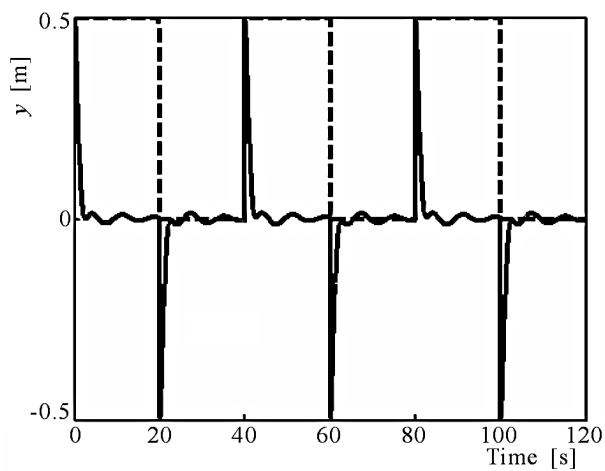

Fig. 9. Closed-loop time response to disturbance

For numerical simulations two kinds of dynamic loadings acting on one side of a building structure in horizontal direction are applied, namely, random white noise modeling an earthquake loading and periodic sinusoidal pressure modeling a wind loading (Baniotopoulos and Plalis, 2002).

Building structures have considerable resistance to dynamic loadings in the vertical direction. In the horizontal direction, buildings are quite vulnerable to external excitations. Thus, it is reasonable to investigate the minimization of the response of a building in the horizontal direction. The responses of the open-loop and closed-loop systems are compared. The comparison is based on the reduction of the magnitude of the maximum horizontal displacement. The

horizontal displacements of the building structure due to earthquake and wind loadings are presented in Fig. 10 and Fig. 11. The maximum magnitude of the horizontal displacement due to earthquake and wind loadings are reduced by 80% and 74%.

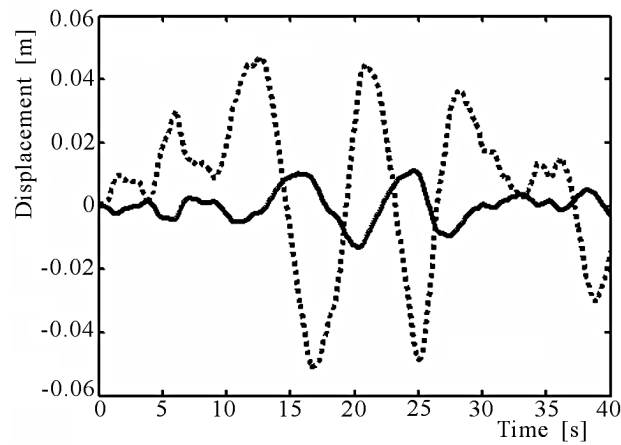

Fig. 10. Time response of controlled (solid) and free (dot) systems due to earthquake

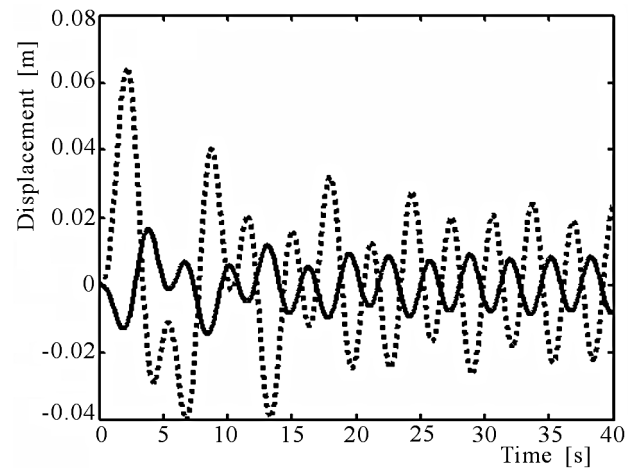

Fig. 11. Time response of the controlled (solid) and free (dot) systems due to wind

## 8. Conclusions

In this paper, structured uncertainties of the main physical parameters (mass, damping and stiffness matrices) have been introduced into the dynamical model of a simple structure. They reflect errors between the model and the reality.



The model of the uncertain system has been presented in a linear fractional transformation frame. Feedback properties for the actively controlled structure have been discussed. Robust stability and robust performance conditions have been considered. Then, a robust control design problem has been formulated within a linear fractional transformation framework using the  $H_\infty$  technique. The  $H_\infty$  norm of the closed loop transfer matrix from all disturbances (external and structured uncertainties) to the errors to be minimized has been chosen as the cost functional. A suboptimal controller has been used for numerical modeling. The closed-loop controlled system has been simulated using a periodic impulsive command input, periodic isolated influences, random white noise forces and a periodic sinusoidal pressure. It has been shown that the derived active robust control strategy ensures good feedback properties of the system, good robust stability and robust performance, and can considerably reduce the effect of structural deformations against external excitations.

It must be emphasized that the framework of the structured uncertainty employed in this paper is quite general and covers interesting cases of practical importance. One could imagine a detailed study of the effect of uncertainty on the damping or the effect of isolated elements of the stiffness matrix which may indicate localized damage in elements or structural joints.

### References

1. ARVANITIS K.G., ZACHARENAKIS E.C., SOLDATOS A.G., STAVROULAKIS G.E., 2003, New trends in optimal structural control, *Selected Topics in Structural and Mechatronic Systems*, A. Belyaev, A. Guran (Edit.), Chapter 8, 321-416, World Scientific, Singapore
2. BANIOPOULOS C.C., PLALIS T.A., 2002, *Wind Action on Civil Engineering Structures According to Eurocode 1-2.4 and Applications on Slender Structures*, KTIRIO-Scientific Publication A
3. HOUNSER G.W., BERGMAN L.A., 1997, Structural control: past, present and future, *Journal of Engineering Mechanics*, **123**, 9, 897-971
4. JABBARI F., SCHMITENDORF W.E., YANG W.E., 1995,  $H_\infty$  control for seismic-excited buildings with acceleration feedback, *J. Engineering Mechanics*, **121**, 994-1002
5. KOBORI T., 1956, *Quake Resistant and Nonlinear Problems of the Structural Vibrations to Violent Earthquake*, J. Kyoto University Disaster Prevention Laboratory, 5th Anniversary Edition, 116-124
6. KOBORI T., MINAI R., 1960, Analytical study on active seismic response control: seismic-response-controlled structure, *Trans. Architectural Institute of Japan*, **66**, 257-260

7. MARINOVA D.G., STAVROULAKIS G.E., 2002, Optimal control for smart structures, *Proc. 28th Int. Summer School AMEE*, Bulgaria, 208-215
8. MARINOVA D.G., STAVROULAKIS G.E., ZACHARENAKIS E.C., 2002, Numerical experiments in optimal structural control, *4th GRACM Congress on Computational Mechanics*, GRACM 2002, Greece
9. PACKARD A., DOYLE J.C., 1993, The complex structured singular value, *Automatica*, **29**, 71-109
10. SMITH H.A., CHASE J.G., 1994, Robust disturbance rejection using  $H_\infty$  control for civil structures, *Proc. First World Conf. on Struct. Control*, TP4, 33-42
11. SUHARDJO J., SPENCER B.F., KAREEN A., 1992, Frequency domain optimal control of wind exited buildings, *J. Engrg. Mech., ASCE*, **118**, 12, 2463-2481
12. ZACHARENAKIS E.C., 1997, On the disturbance attenuation and  $H_\infty$  optimization in structural analysis, *ZAMM*, **77**, 189-195
13. ZHOU K., 1998, *Essentials of Robust Control*, Prentice-Hall, Upper Saddle River, NJ

### Projektowanie sterowania odpornego w "inteligentnych" konstrukcjach budowlanych

#### Streszczenie

Praca przedstawia aplikację metody projektowania optymalnego sterowania odpornego  $H_\infty$  dla celów konstrukcyjnych. Rozważono dynamiczny model konstrukcji budowlanej poddanej obciążeniu trzęsieniem ziemi oraz wiatrem. Wprowadzono niepewność strukturalną do modelu, aby odzwierciedlić błędy wynikające z różnic między modelem i budynkiem rzeczywistym. Do uzyskania najlepszego działania układu sterowania w obecności założonego poziomu niepewności parametrów użyto w analizowanej aktywnej konstrukcji tzw. sterowania odpornego  $H_\infty$ . W rozwiązywaniu problemu sterowania zastosowano symulacje numeryczne wspomagane gotowymi procedurami zaczerpniętymi ze środowiska MATLAB. Poprzez odpowiedni dobór współczynnika wagi uzyskano znaczący efekt redukcji wrażliwości sejsmicznej budynku. Wyniki badań pokazały wysoką odporność zaproponowanego układu sterowania.

*Manuscript received August 3, 2006; accepted for print September 13, 2006*