

ON THE CALCULATION OF THE VELOCITY INDUCED BY A VORTEX-SOURCE CONE

K. VARSAMOV, K. YOSIFOV, A. HAIMOV (WARNA)

The present paper describes the transition from numerical quadrature to linearized expressions for calculation of the velocity induced by unit vortex cone at points near the vortex sheet. A criterion is obtained by comparing the results with the exact solution for singularity distribution of constant strength.

I. The method of singularities is often used for solving axisymmetric potential flow problems in doubly connected regions (ring aerofoils, bodies in ducts, etc.). The bodies are represented by a vortex or source-vortex distribution along the so called camber surfaces. The strength of the singularities gives the velocity at any point of the flow by numerical quadrature. The numerical integration for the velocity at a control point near a vortex sheet becomes inaccurate due to the singularity of the integrand at points on the sheet.

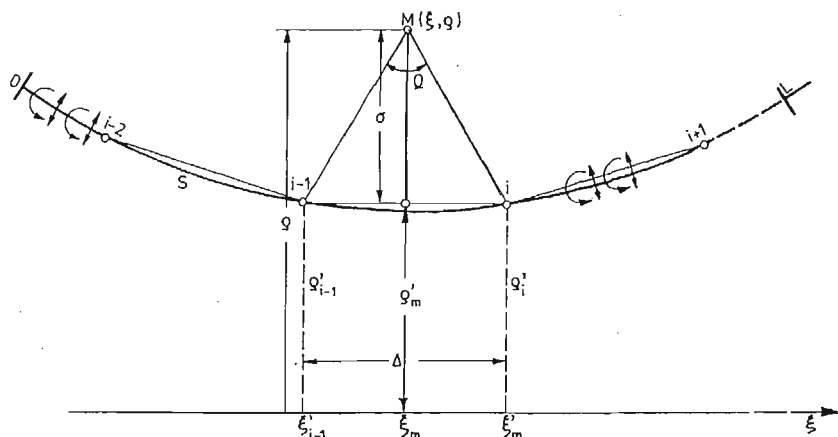

Rys. 1

Consider a continuous vortex or source-ring distribution of strength  $\gamma(s')$ ,  $q(s')$ , respectively, along a camber line  $s$  (see fig. 1) and the control point  $M$  located near  $s$ . Any component of the velocity induced by such a sheet may be written as

$$(1) \quad C = \int_0^L \gamma(s') \cdot F(S, S') ds' = \sum_{i=1}^N \lambda_i \cdot \gamma_i \cdot F_i,$$

where  $\lambda_i$  are the weight coefficients of the quadrature. It was mentioned in [1] that the increasing error of quadrature formula for small values of  $b$  forces a special consideration of the interval  $\Delta = \xi'_i - \xi'_{i-1}$ . Eq. (I) can be expressed in the form

$$(2) \quad C = \sum_{j=1}^{i-1} \lambda_j \gamma_j F_j + \sum_{j=i}^N \lambda_j \gamma_j F_j + c^*$$

where

$$(3) \quad c^* = \int_{s_{i-1}}^{s_i} \gamma(s') \cdot F(S, S') \cdot ds'.$$

The exact solution of the integral (3) can be found by using linearization of the camber line and the vortex strength and setting

$$(4) \quad \begin{aligned} \varrho'(\xi') &= \varrho'_m + a \cdot \xi', \\ \gamma(\xi') &= \gamma_m + e \cdot \xi', \\ q(\xi') &= q_m + f \cdot \xi', \end{aligned}$$

where  $a, e, f$  are the corresponding derivatives and  $\varrho'_m, \gamma_m, q_m$  — the mean values.

For the axial and radial velocity components from (I) in [1] and [2] we obtain:

$$(5) \quad \begin{aligned} u_v^* &= \frac{\gamma(\xi')}{2\pi(\varrho + \varrho'_m)} \left\{ \left[ \ln \left( \frac{4(\varrho + \varrho'_m)}{\sqrt{1+a^2}} \right) - \frac{1}{4} \ln(A^+ \cdot A^-) \right] \Delta + \right. \\ &\quad + \frac{a}{1+a^2} \left( \varrho'_m + \frac{b}{2} \right) \ln \frac{A^+}{A^-} - \frac{b}{|b|} \cdot \frac{2\varrho'_m + b}{1+a^2} \Omega + e \left[ \frac{a(4\varrho'_m + b)}{2(1+a^2)} \Delta + \right. \\ &\quad \left. \left. + \left( \frac{2c^2 - d}{4} - \frac{\varrho'_m}{1+a} (2ac - b) - \frac{\Delta^2}{16} \right) \ln \frac{A^+}{A^-} - \frac{a \cdot |b|}{(1+a^2)^2} (4\varrho'_m + b) \Omega \right] \right\}, \end{aligned}$$

$$(6) \quad \begin{aligned} V_v^* &= \frac{\gamma(\xi')}{2\pi\varrho(\varrho + \varrho'_m)} \left\{ \frac{c}{2} \Delta + \left( \frac{c^2}{2} - \frac{d}{4} - \frac{\Delta^2}{16} - \frac{\varrho\varrho'_m}{1+a^2} \right) \ln \frac{A^+}{A^-} - \right. \\ &\quad - a \frac{b}{|b|} \left[ 2\varrho \cdot \varrho'_m + \frac{b}{1+a^2} \right] \frac{\Omega}{1+a^2} + e \left[ \left( \frac{2c^2 - d}{3} - \frac{2\varrho\varrho'_m}{1+a^2} \right) \Delta + \right. \\ &\quad \left. \left. + \frac{c}{6} \left( 4c^2 - 3d - 12 \frac{\varrho\varrho'_m}{1+a^2} \right) \ln \frac{A^+}{A^-} - \frac{|b|}{3(1+a^2)^3} [b^2(3a^2 - 1) - 6\varrho\varrho'_m(1 - a^4)] \Omega \right] \right\}, \end{aligned}$$

$$(7) \quad \begin{aligned} u_q^* &= \frac{q(\xi')}{2\pi} \cdot \frac{2\varrho'_m}{\varrho + \varrho'_m} \cdot \frac{1}{1+a^2} \left[ \frac{1}{2} \ln \left| \frac{A^+}{A^-} \right| + \right. \\ &\quad \left. + \frac{ab}{|b|} \Omega + f \left( \Delta + \frac{ab}{1+a^2} \ln \frac{A^+}{A^-} + |b| \frac{a^2 - 1}{a^2 + 1} \Omega \right) \right], \end{aligned}$$

$$(8) \quad \begin{aligned} V_q^* &= \frac{q(\xi')}{2\pi} \cdot \frac{\varrho'_m}{\varrho(\varrho + \varrho'_m)} \left\{ \left[ \ln \frac{4(\varrho + \varrho'_m)}{\sqrt{1+a^2}} - \frac{1}{4} \ln A^+ A^- \right] \Delta + \right. \\ &\quad + \frac{a}{1+a^2} \left( \frac{b}{2} - e \right) \ln \frac{A^+}{A^-} + \frac{b}{|b|} (2\varrho - b) \frac{\Omega}{1+a^2} + f \left[ \left( \frac{c}{2} - \frac{2\varrho \cdot a}{1+a^2} \right) \Delta + \right. \\ &\quad \left. \left. + \left( \frac{c^2}{2} - \frac{d}{4} - \frac{\Delta^2}{16} - \frac{\varrho \cdot b}{1+a^2} - \frac{2\varrho \cdot a \cdot c}{1+a^2} \right) \ln \frac{A^+}{A^-} + \frac{a \cdot |b|}{(1+a^2)^2} (4\varrho - b) \Omega \right] \right\}. \end{aligned}$$

where the notation is expedient from fig. 1:

$$(9) \quad \begin{aligned} c &= \frac{a \cdot b}{1+a^2}; & d &= \frac{b^2}{1+a^2}; \\ \left| \left( \frac{\Delta}{2} \right)^2 - 2c \left( \frac{\Delta}{2} \right) + d \right| &= A^+; & \left| \left( \frac{\Delta}{2} \right)^2 + 2c \left( \frac{\Delta}{2} \right) + d \right| &= A^-; \\ \operatorname{arctg} \left( \frac{\frac{\Delta}{2} - c}{\sqrt{d - c^2}} \right) - \operatorname{arctg} \left( \frac{-\frac{\Delta}{2} - c}{\sqrt{d - c^2}} \right) &= \Omega; \end{aligned}$$

2. The above equations for the induced velocity have been applied to the numerical solutions [1] [3] of the inverse hydrodynamic problem for propelling complex in partially nonlinear formulation. They have been used not only for calculation of the camber ( $b = 0$ ) lines, but also for the construction of duct's profile in case of control points situated near the camber line. For the points sufficiently distant from the camber line the contribution of the vortex-source cone containing in its interval the control point is obtained from (1). The trapezoidal rule is used in both solutions. It is obvious that the boundary value of  $b$ , which gives more accurate result using eq. (5÷8) than the trapezoidal rule must be obtained for the considered interval. The purpose is to obtain a smooth transition in accuracy for both formulas.

3. The solution of the problem in [1] is obtained empirically by numerical tests in quite a narrow interval along the duct profile ( $\sim 0.5$ ) and about 20 points used in the case of large relative thickness. The results of computations [3] show that it is not convenient to use a fixed value of  $b$  like a transition criterion from (1) to (5÷8). Obviously, the variation of the number of points with other parametres fixed changes the length of the interval  $\Delta$  (fig. 1) and the relative position of the control point  $M$  towards the influencing cone. That is why the comparison of the accuracy of (5÷8) and the quadrature formulae will be made for normalized values of  $b$ ,  $q = \frac{b}{\varrho'_m}$ ,  $p = \frac{\Delta}{\varrho'_m}$ . Only the main components  $u_v^*$  and  $v_a^*$  will be discussed.

4. Consider the influence of vorticity distributon of constant strength placed along a cylindrical surface. Hence, assuming that  $\gamma = \text{const}$ ,  $q = \text{const}$ , where  $a = 0$ ,  $e = 0$ ,  $f = 0$ ,  $c = 0$ ,  $d = b^2$ , from eq. (5) and (8) we obtain the expressions:

$$(10) \quad \bar{u}_v^* = \frac{4\pi}{\gamma} u_v^* = \frac{1}{p} \left\{ \ln 8 \frac{P}{Q} - \operatorname{sign}(b) \cdot 2P \cdot \Omega \right\},$$

$$(11) \quad \bar{v}_a^* = \frac{4\pi}{q} v_a^* = \frac{1}{R} \left\{ \ln 8 \frac{P}{Q} + \operatorname{sign}(b) 2P \cdot \Omega \right\},$$

where

$$P = \frac{1}{p} \left( 1 + \frac{q}{2} \right), \quad Q = \frac{|q|}{p} \sqrt{\frac{1}{4} \left( \frac{p}{q} \right)^2 + 1},$$

$$R = \frac{(1-q)(1+q/2)}{p}, \quad \Omega = 2 \operatorname{arctg} \frac{p}{2|q|},$$

$$p = \frac{\Delta}{\varrho'_m}, \quad q = \frac{b}{\varrho'_m}.$$

It is sufficient to analyze eq. (10). The simple chosen scheme gives the possibility to calculate the exact values of the velocity, substituting the vorticity distribution by two equivalent source disks (fig. 2). This suggests the solution

$$(12) \quad \bar{u}_v^* = u_{D_1} + u_{D_2},$$

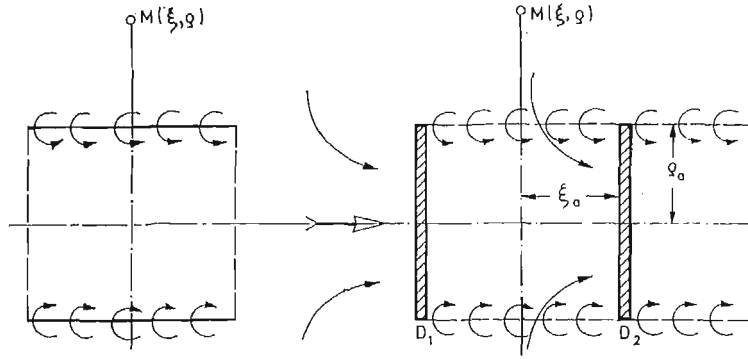

Rys. 2

where

$$(13) \quad u_D = \frac{\varrho_a}{2\pi} \left\{ A + \frac{\xi - \xi_a}{(\xi - \xi_a)^2 + (\varrho + \varrho_a)^2} \left[ K(k) - \frac{\varrho - \varrho_a}{\varrho + \varrho_a} \Pi(m^2, k) \right] \right\},$$

$K(k)$ ,  $E(k)$ ,  $\Pi(m^2, k)$  are the complete elliptic integrals of first, second and third kind with arguments  $K = \sqrt{\frac{4p\varrho'}{(p+p')^2 + (\xi - \xi')^2}}$ ,  $m^2 = \frac{4p}{(\varrho + \varrho_a)^2}$

Fig. 3, 4, 5 and 6 show certain results of calculations obtained by the use of the three methods (eq. (1), (10) and (12) for which computer programs were written. The results

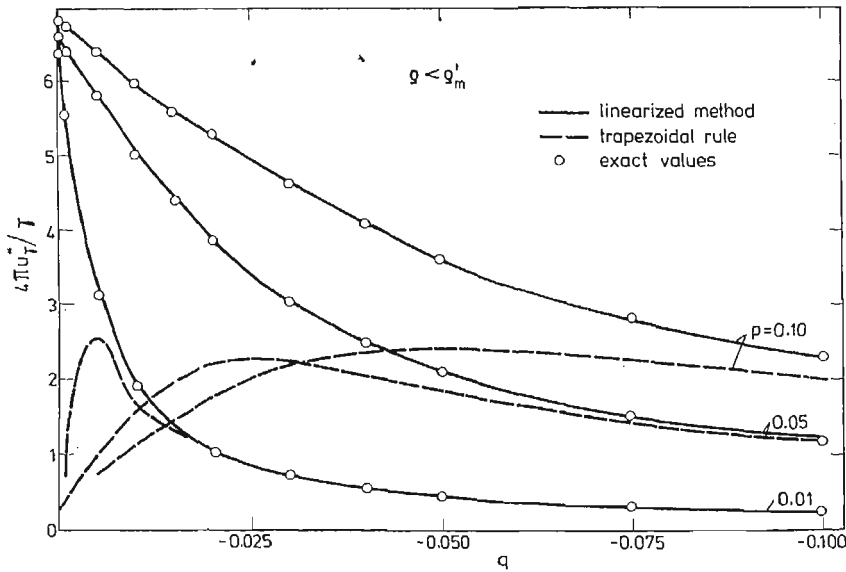

Rys. 3

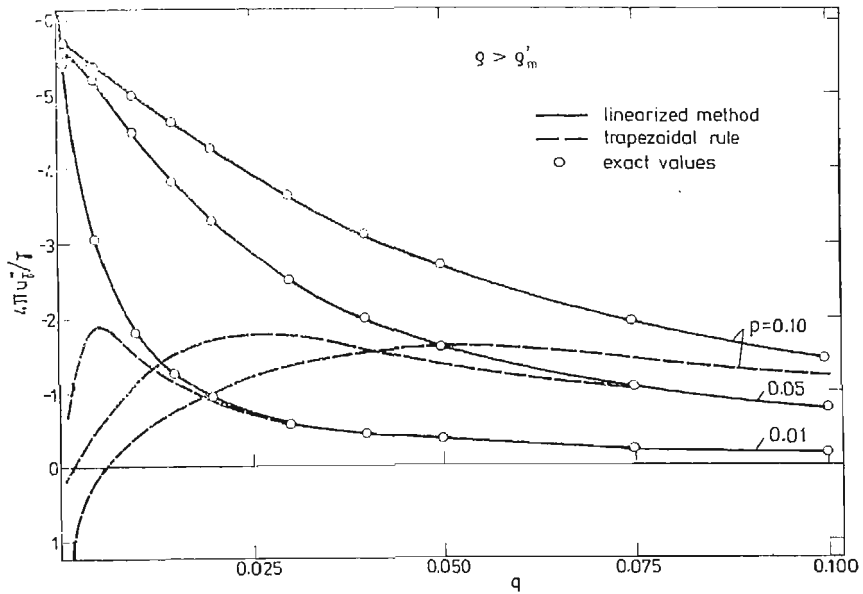

Rys. 4

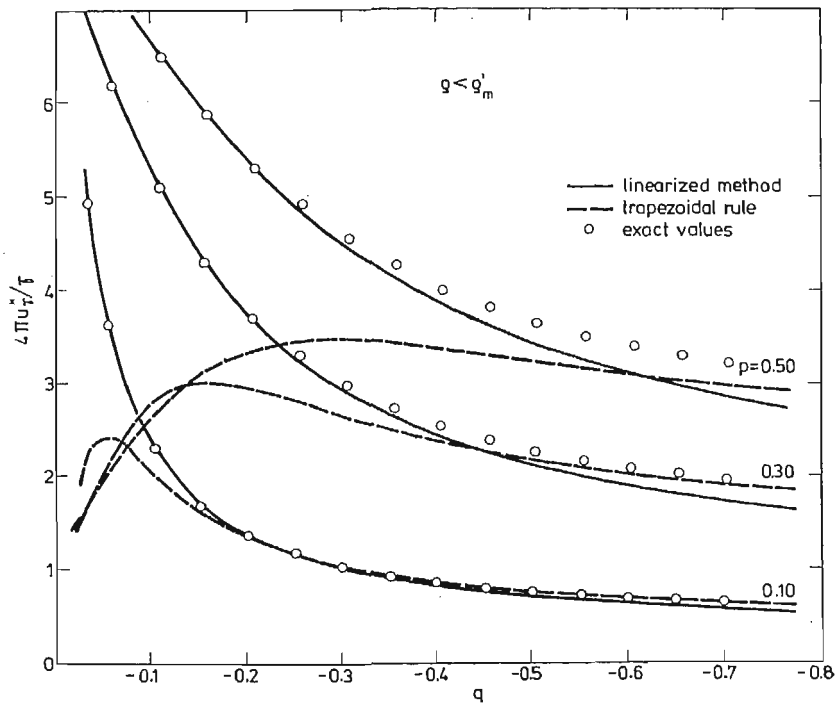

Rys. 5

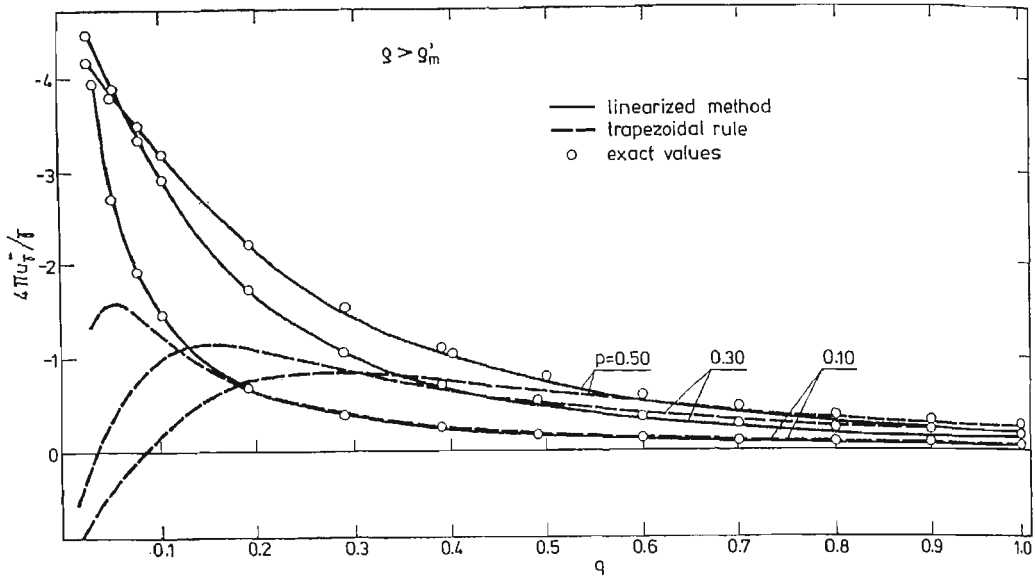

Rys. 6

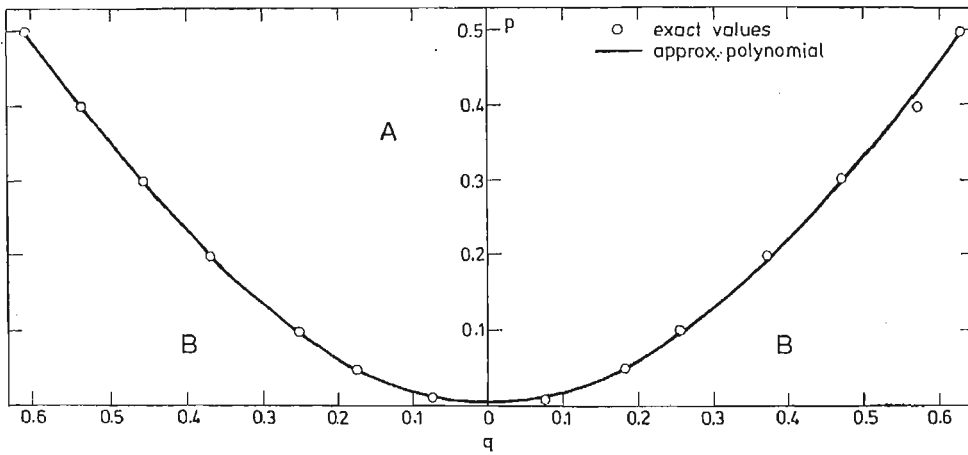

Rys. 7

of (10) and (12) are in good agreement, specially for small values of  $|q|$ , where the error of the quadrature formula increases rapidly. Increasing the value of  $q$  we obtain that, the accuracy of both methods becomes equal and next the results from (1) are better.

The behaviour of the solution permits to obtain the curve  $p = f(q)$  plotted in fig. 7 which, gives the same accuracy in using both formulae. In the interval  $-0,6 < q < 0,6$  the function is approximated by the polynomial

$$(14) \quad p = -0,5393 \cdot q^4 - 0,0852 \cdot q^3 + 1,494 \cdot q^2 - 0,445 \cdot 10^{-3}q + 0,386 \cdot 10^{-2}$$

The resulting formula defines two regions  $A$  and  $B$  which correspond to the sufficiently accurate use of eq. (10) and (I), respectively.

As a concluding remark it should be mentioned that eq. (14) permits the automatic transition from numerical quadrature to linearized expressions in calculating the velocity, induced by a vortex-source come in points of its neighbourhood.

#### References

1. M. POPOV, K. VARSAMOV, *Ducted Propeller Design Method*, Theor. and Appl. Mechanics, Nr. 2, I 1970 (in Bulgarian).
2. K. YOSIFOV, K. VARSAMOV, G. GENTCHEV, *On the Ducted Propeller Design*, Reports of the First National Conference on Fluid Mechanics and Fluid Machinery, Varna. 1975 (in Bulgarian).
3. N. LUDSKANOV, L. PANOV, *Potential Flow of Incompressible Fluid around Arbitrary Profile*, Annual Journal Appl. Mechanics, Nr. 2, vol. III, 1967 (in Bulgarian).

#### Резюме

#### ВЫЧИСЛЕНИЕ СКОРОСТИ ПОРОЖДЕННОЙ ВИРОВЫМ КОНУСОМ

В работе рассматривается переход от вычислительной квадратуры до линеаризованных формул на скорость порожденную единичным вихревым конусом в точках в окрестности вихревого слоя.

Из сравнения результатов с точным решением получен критерий для сингулярного распределения вихря о постоянной интенсивности.

#### Streszczenie

#### WYZNACZANIE PRĘDKOŚCI PRZEPLYWU WYWOŁANEJ WIROWYM STOŻKIEM

W pracy przedyskutowaliśmy przejście od kwadratury numerycznej do zlinearyzowanych wzorów obliczeniowych, z których wyznaczona została prędkość przepływu wywołana jednostkowym stożkiem wirowym w punktach w pobliżu warstwy wirowej. Przez porównanie wyników z rozwiązaniem ścisłym otrzymano kryterium na rozkład osobliwości o stałej wydajności.

*Praca została złożona w Redakcji dnia 11 listopada 1980 roku*

---