

AUTOMATIC DIGITAL IMAGE-PROCESSING IN PHOTOELASTICITY*

KARL HANS LAERMANN

Bergische Universität — GH Wuppertal

1. Introduction

Automatic digital image-processing has become very important in the field of remote sensing, in topographic mapping, in quality control, and in medicine, i.e. in the field of pattern recognition. In experimental stress analysis, image-processing has been introduced at first in Moiré techniques and in holographic and speckle interferometry. Application in photoelasticity is not very common as yet, because special problems are still not solved. Image-processing in photoelasticity demands recording, separating and separate evaluation of two different types of fringe pattern, the isochromatic fringes and the isoclinics. Algorithms for filtering, contour mapping, elimination of background intensities and localization of extrema are to be developed for isochromatic fringes, and the varying course of those patterns must be considered. The determination of isoclinics is especially difficult due to the lack of video-cameras in differentiating colors.

Therefore algorithms are derived and procedures are described to improve digital image-processing in photoelasticity.

2. Image-preprocessing

In photoelasticity two different fringe patterns (isochromatic fringes and isoclinics) are to be recorded and evaluated separately. The intensity of each pattern is denoted as "image", which will be described by a discrete function of two integer variables, the coordinates of the single pixels of the imaging system. Because of the 8-bit-characteristic of A/D -converters, the intensity is divided into $l = 256$ shades of gray

$$I = f(x, y), \quad I \in [1/l], \quad X \in [1/n], \quad Y \in [1/m]. \quad (1)$$

The recorded data of intensity consist of intelligent signals and noise signals. The latter must be divided into i) local-invariant but time-variant, and ii) time-invariant but strongly local-variant noise.

Local-invariant noise which for example might be caused by intensity variation of the

* Praca wygłoszona na XII Sympozjum Doświadczalnych Badań w Mechanice Ciała Stałego Warszawa-Jadwisin, 1986.

light source and by the video target, the A/D-converter etc. are appreciably reduced by averaging the intensity function recorded over time, an image-storing process:

$$\bar{I}(x, y) = \frac{1}{\vartheta} \sum_{\vartheta} f_{\vartheta}(x, y) \quad (2)$$

with ϑ , the number of scanning repetition. The local-variant noise is caused by bubbles, scratches, schlieren in the photoelastic model itself, by inhomogeneity, spots and other defects of the optical filters and the video target. Also the uneven illumination by the light-source must be considered.

As the Fourier-transformation may not be recommended because of limited memory capacity of the considered computer systems, procedures of lowpass-filtering are introduced, i.e. from a mathematical point of view the transformation of a function $f(x, y)$ onto a new image function $g(x, y)$: in a discrete point of the image $g(x, y)$ depends on the values of $f(x, y)$ in the neighbourhood U of the considered point. As local operator of transformation, a balanced matrix $h(x, y, i, j)$ is introduced with the window $M = (2k+1) \cdot (2k+1)$ pixels to describe the neighborhood U .

The relation between this balanced matrix and the local coordinates is difficult to describe; therefore a local-invariant filter, i.e. a homogeneous local operator $h(i, j)$, will be used. This convolution process holds (Fig. 1):

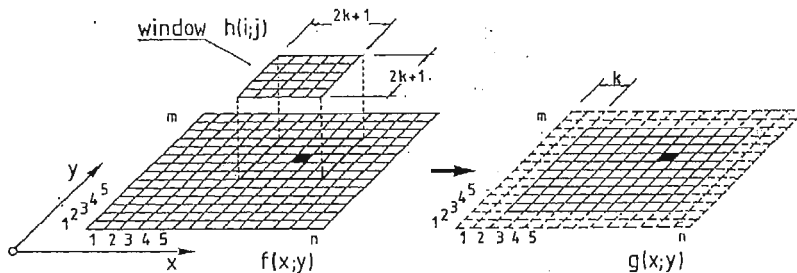

Fig. 1.

$$g(x, y) = \sum_{i=-k}^{+k} \sum_{j=-k}^{+k} f(x+i, y+j) \cdot h(i, j) \hat{=} f * h. \quad (3)$$

In digital image-processing generally a data-reduced binary image is produced from the gray tints-image by determining a threshold value $I_{Schwell}$ and then allotting the shades of gray for "Low" and "High", if $I(x, y) < I_{Schwell}$ or $> I_{Schwell}$ respectively.

But in photoelasticity important informations are lost by such a binary notation as shown for instance in Fig. 2.

It is of utmost importance to obtain exact data of the localization of extrema and to maintain them. Therefore median-, dilatation- and erosion-filtering are not suitable as well. As it has been proved by Perzborn [1], balanced mean valuefiltering yields less dynamic compression as well as faster calculation process and maintains the coordinates of

the extrema of the fringe pattern. The local operator holds:

$$h_{bm}(i, j) = \frac{1}{\sum \psi_{ij}} \begin{bmatrix} \psi_{-k, +k} & \dots & \psi_{0, +k} & \dots & \psi_{+k, +k} \\ \psi_{-k, 0} & \dots & \psi_{0, 0} r_{i, j} & \dots & \psi_{+k, 0} \\ \psi_{-k, -k} & \dots & \psi_{0, -k} & \dots & \psi_{+k, -k} \end{bmatrix} \quad (4)$$

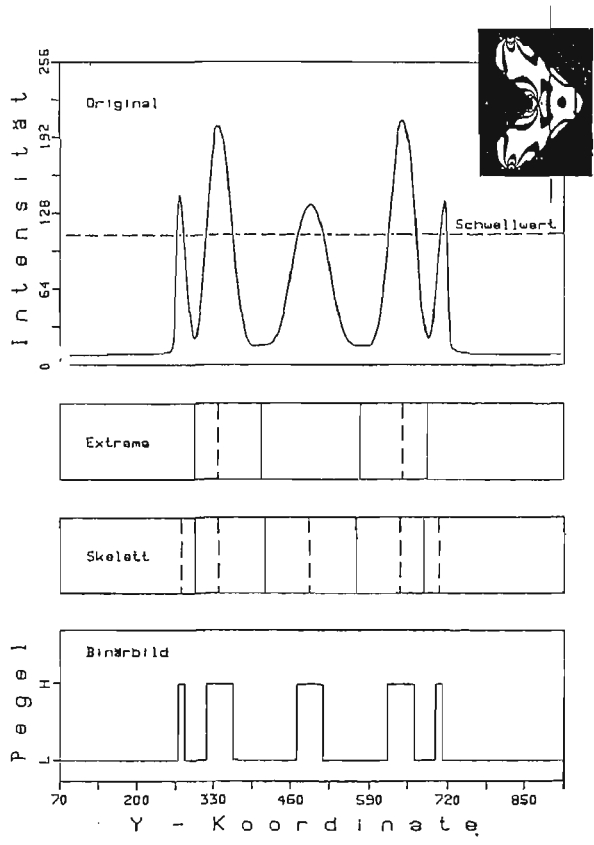

Fig. 2.

The elements of this matrix may be calculated e.g. according to the following formulas:

$$\psi_{i,j} = 0,5 \frac{1}{r_{ij}}; \quad \psi_{i,j} = 0,5 \frac{1}{(r_{i,j})^2}; \quad \psi_{0,0} = 1; \quad (5)$$

with:

$$r_{i,j} = (i^2 + j^2)^{1/2}.$$

Then the transformation yields the discrete function of intensity:

$$\hat{I}(x, y) = \sum_{i=-k}^{+k} \sum_{j=-k}^{+k} \hat{I}(x+i, y+j) \cdot h_{bm}(i; j) \hat{=} (\hat{I} * h_{bm})(x, y). \quad (6)$$

To eliminate the background intensity, recurrent convolution as commonly used is not suitable in photoelasticity (Fig. 3).

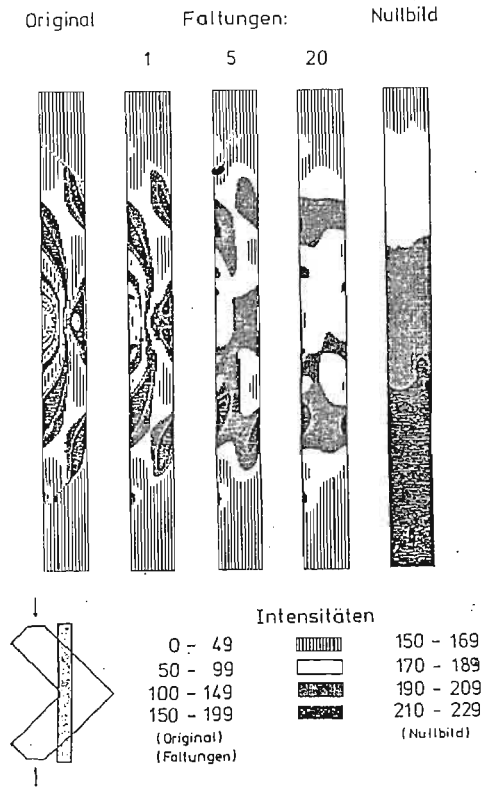

Fig. 3.

Therefore a “zero image” is taken in a circular light-field (in a circular darkfield a background does not exist, but local-variant noise only) and is stored as a zero intensity matrix \hat{I}_0 after filtering, as described before. Contrary to the Moiré technique and holographic interferometry, the background intensity is related multiplicatively with the fringe intensity. But as division of $\hat{I}(x, y)$ by $\hat{I}_0(x, y)$ leads towards a high dynamic reduction, the quotient is multiplied with the maximum value \hat{I}_{max} of the intensity observed on the model and taken by a histogram. Furthermore, there exists a minimum light intensity \hat{I}_{min} caused for instance by the dark-current-response of the video camera and by scattering light. \hat{I}_{min} may be estimated regarding the background intensity of the dark field.

The now filtered and corrected intensity function finally holds:

$$I^*(x, y) = \frac{\hat{I}(x, y) - \hat{I}_{min}}{\hat{I}_0(x, y)} \hat{I}_{max}. \quad (7)$$

3. Contour mapping

For further evaluation the exact contour lines of the model must be determined. At first, the surface of the model may be powdered to reduce its transparency. Then a threshold value

$$I_c = \frac{1}{2} (I_{max} + I_{min}) \quad (8)$$

will be taken in a circular light field. However, the contour lines are smeared. Therefore they must be intensified by a gradient procedure. For a window $(2k+1) \times (2k+1)$ the

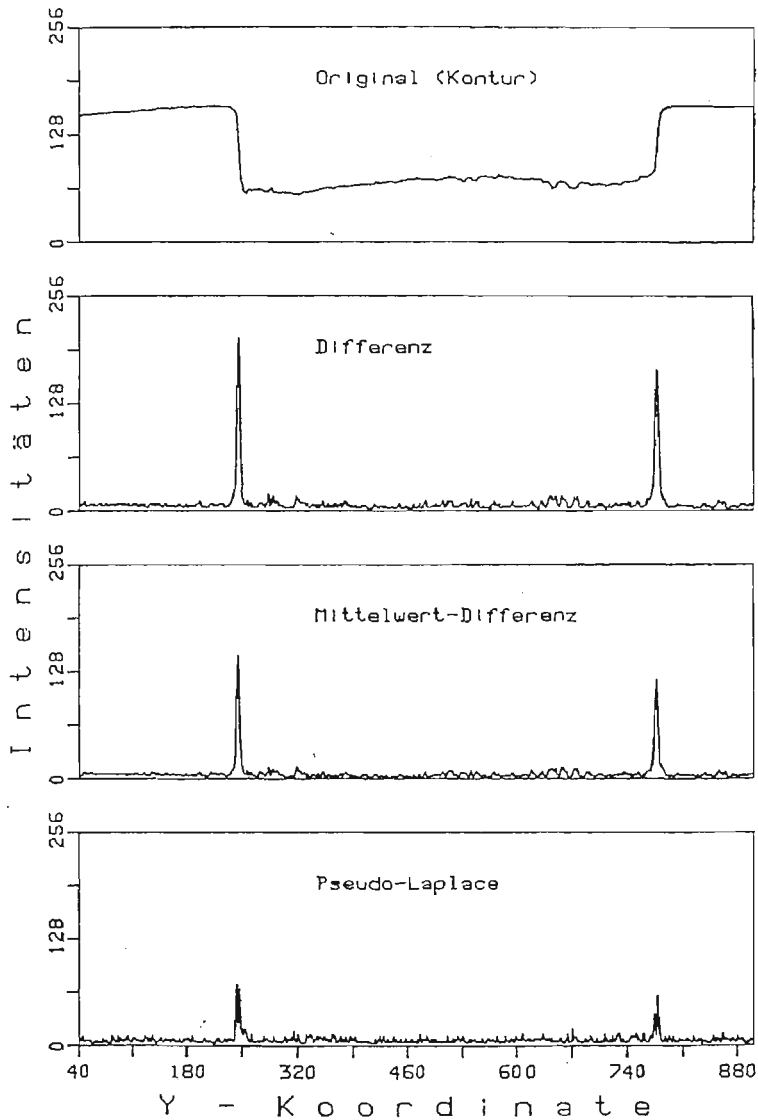

Fig. 4.

maximum of the absolute values of i) the four discrete first derivatives in the direction of the x -axis, the y -axis and $\pm 45^\circ$ to these axes, or ii) the second derivatives (pseudo-Laplace), or iii) the mean value differential calculus will be determined. The maximum of intensity then yields the exact coordinates of the contour. This process of nonlinear transformation is described by:

$$\hat{I}_{Cont}(x, y) = \text{Max}(|\hat{I} * h_{\alpha\beta}|), \quad (9)$$

where: α denotes one of the processes i) to iii), and β the direction $(x, y, +45^\circ, -45^\circ)$ (Fig. 4).

After filtering and contour mapping, the values of intensity of the object only are stored column by column.

4. Positioning of extrema

It is not possible to measure the absolute values of intensity. Otherwise the problem would have been solved already. As mentioned before, filtering of local-invariant and local-variant noise, the background intensity and especially the dynamic compression because of the modulation transmission function are influencing the shades of gray. Therefore the coordinates of extrema are determined only.

4.1 Isochromatic fringes. A characteristic value k_N is assigned to each pixel. Now in the evaluation process these characteristic values are changed in different steps if the pixel

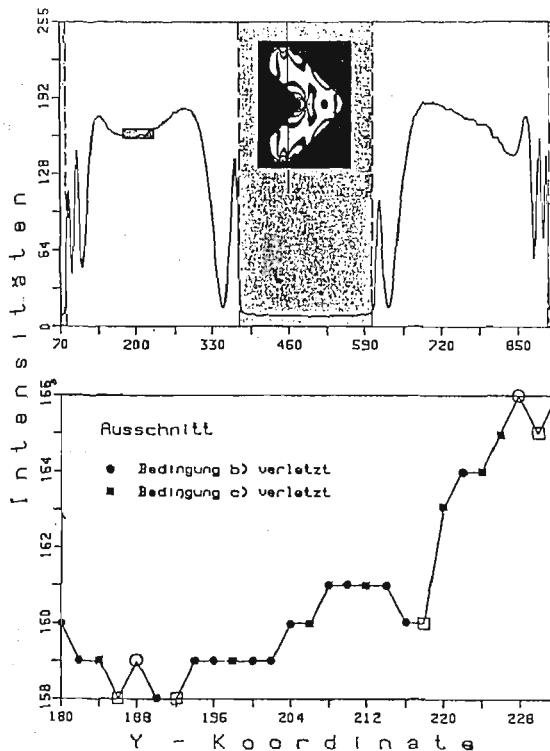

Fig. 5.

is not relevant as loci of extrema. Those points are relevant only the values k_N of which remain unchanged during the whole process. In a first step k_N remains unchanged if:

- i) the points are inside the domain G of the object, $(x, y) \in G$;
- ii) in case of equal intensity in the vicinity, the considered point corresponds to the centre point;
- iii) inside the window the intensity of a pixel is detected as a relative extremum. In a domain, where the interference fringes are very dense, this condition already yields the coordinates of the extrema (Fig. 5).

In a second step a threshold value will be determined for each column by averaging the intensity values of the preliminary extrema. The variation of the threshold value $I_{Schwell}$ from column to column must be very small. If the difference of the threshold values of successive columns is larger than a given measure ΔI , the values will be balanced. The characteristic value k_N remains unchanged, if:

- i) the intensity of a minimum $< I_{Schwell}$;
- ii) the intensity of maximum $> I_{Schwell}$ (Fig. 6).

In the third step, expected areas of intensity are determined by comparison of the extreme intensity values in the single columns. Except in areas of high fringe density, the extrema must lay in the expected areas, otherwise k_N is to change, i.e. the considered point will be eliminated as loci of extremum (Fig. 7). The intensity of an extremum can be figured out of the intensity of the successive preliminary extrema of the other kind and the threshold value, regarding a range of variation I_Δ :

$$I_{min}(k; j) \leq 2I_{Schwell} - \frac{1}{2} [I_{max}(l; j) + I_{max}(l+1; j)] + I_\Delta, \quad (10)$$

$$I_{max}(l; j) \geq 2I_{Schwell} - \frac{1}{2} [I_{min}(k; j) + I_{min}(k+1; j)] - I_\Delta.$$

The observance of these conditions can be demanded for the whole domain G of the object. k_N is changed for those pixels, in which the conditions according to eq. (10) are not satisfied (Fig. 8).

Comparing the loci of extrema column by column, shiftings may be observed. These shiftings are to be eliminated by a correction algorithm. Limiting values of intensity and of the coordinates of extrema are given.

Then the final loci of extremum within the window is determined as the central point within the limiting values of intensity, if the coordinates within the respective limiting values.

In photoelasticity, the interference fringes are sometimes parallel or almost parallel to the direction of scanning, and as the data are stored sequentially, the direction of evaluation coincides with the direction of scanning, and in consequence, dislocations of the extrema from column to column may appear. To correct the errors, the complete matrix of the image is transformed: $I^*(x, y) \rightarrow I^*(y, x)$. Then the same process of localizing the extrema is applied as before. The coordinates of the extrema given by the evaluation in two orthogonal directions are compared and balanced in case of differences.

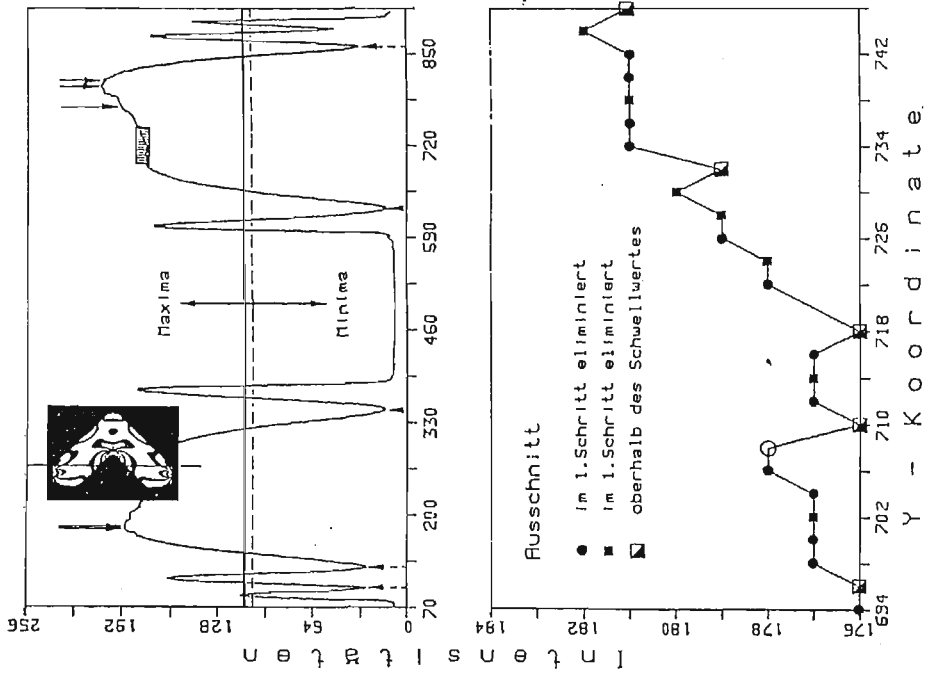

Fig. 6.

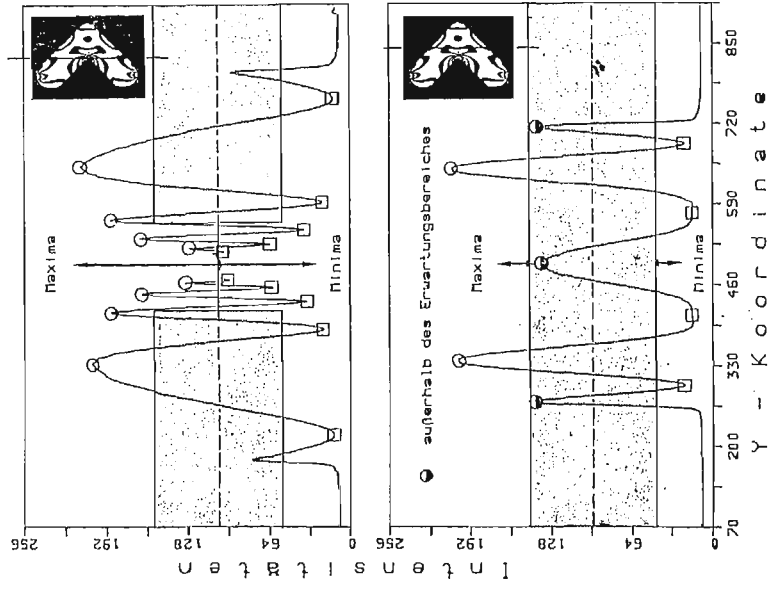

Fig. 7.

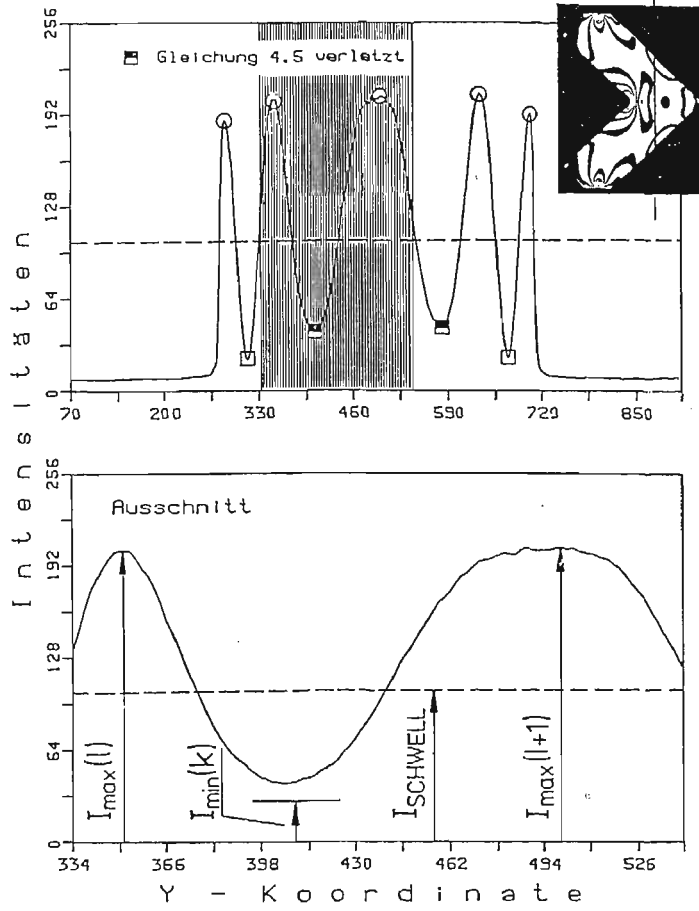
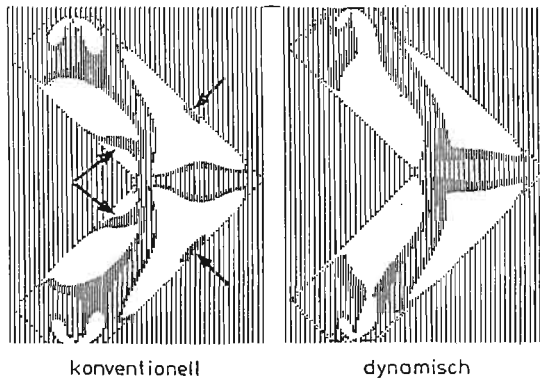

Fig. 8.

0° -Isokline



belastet
Fig. 9.

4.2 Isoclinics. Under the supposition of elastic response of material, the principal directions of the stress state are independent of the magnitude of the stresses and therefore the isoclinics, too, whereas the isochromatic fringes are changing with the variation of stresses. Thus, by varying the load p , the light intensity holds:

$$I = \sin^2 2\alpha \iint A_x^2(\lambda) \sin^2 \pi \frac{G(p)}{\lambda} d\lambda dp. \tag{11}$$

The isochromatic fringes are then smeared and the loci of minimum intensity yield the coordinates of the isoclinics. Discrete integration of eq. (11) over p is equivalent to image-storing included filtering of local-invariant noise.

Further evaluation has to be done as for isochromatic fringes (Fig. 9).

5. Tracing algorithm

The coordinates of the extrema are stored in integer values (pixel), therefore the mean camber lines always appear as stepped parts of straight lines. Those parts of more than three pixels are registered by the coordinates of the initial and the end point, thus saving memory capacity also. Loci of extrema which are not in direct vicinity of those parts are proved by a neighbourhood matrix. (Fig. 10), whether they are relevant or not.

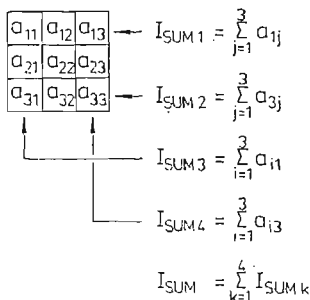

Fig. 10.

Depending on the partial sum, it will be decided, in which direction the search process should proceed. In case of discontinuity, the neighborhood matrix will be enlarged. Because of edgeeffects uncertainties in areas close to the object contour lines may be observed (< 20 pixels). Then the mean camber lines are extrapolated from the internal curves. Finally, smooth curves are produced using parametric cubic spline functions.

6. Conclusions

The described procedures have been developed under the aspect, that microcomputers are available only, and it is even not necessary to use an image-frame-store. The whole programming has been done in overlay-structure. Application is not restricted to photo-

elasticity only, but photoviscoelasticity, non-linear and dynamic problems may be considered also, as well as Moiré techniques and holography.

7. References

1. V. PERZBORN, *Ein Beitrag zur Digitalen Bildverarbeitung in der Spannungsoptik*. Diss. Bergische Universität — HG Wuppertal, Wuppertal, 1986.

Резюме

АВТОМАТИЧЕСКАЯ ЦИФРОВАЯ ОБРАБОТКА ОБРАЗОВ

Обработка образов в фотоупругости требует записи и разделения двух семей кривых: изохром и изоклин. Обработка алгоритмов для фильтрации, отбора разниц интенсивности света и локализации геометрических точек максимальной интенсивности света является необходимой. Определение изоклин является особенно трудным так как не достает видео-камер различающих цветы. В работе выведены алгоритмы и описаны процедуры для улучшения обработки образов в фотоупругости.

Streszczenie

AUTOMATYCZNE CYFROWE PRZETWARZANIE OBRAZÓW

Przetwarzanie obrazów dla elastoptyki wymaga zapisania i rozdzielania dwóch rodzin linii: izochrom i izoklin. Konieczne jest opracowanie algorytmów dla filtracji, eliminacji różnic w intensywności światła i lokalizacji miejsc geometrycznych punktów o maksymalnej intensywności światła. Wyznaczenie przebiegu izoklin jest szczególnie trudne ze względu na brak wideo-kamer rozróżniających kolory. W pracy opisane są algorytmy i procedury dla udoskonalenia przetwarzania obrazów elastoptycznych.

Praca wpłynęła do Redakcji dnia 1 czerwca 1987 roku.
