

## AIRCRAFT DYNAMICS DURING FLIGHT IN ICING CONDITIONS

GRZEGORZ KOWALECZKO  
MICHAŁ WACHŁACZENKO

*Air Force Institute of Technology, Warsaw, Poland*

*e-mail: g.kowaleczko@chello.pl; michal.wachlaczenko@itwl.pl*

This paper presents numerical analysis of airplane motion parameters during wing in-flight icing. The wing external flaps deflection event was taken under consideration. The mathematical model of the airplane motion including twelve ordinary differential equations was employed. Using available publications as well as TS-11 “Iskra” jet trainer geometrical and mass relationships, a computer code evaluating motion parameters of an iced airplane was developed. On the basis of analysis results, conclusions referring airplane dynamic properties during wing ice accretion was formulated.

*Key words:* ice-accretion, wing icing, simulation

### Notations

$\alpha, \beta$  – angle of attack and sideslip

$\Phi, \Theta, \Psi$  – aircraft roll, pitch and yaw angle

$m$  – airplane total mass

$\mathbf{V} = [u, v, w]^T$  – centre of mass of airplane velocity vector

$\mathbf{\Omega} = [p, q, r]^T$  – rotational velocity vector in airplane-fixed system of coordinates

$\mathbf{F} = [X, Y, Z]^T$  – external forces vector acting on the airplane

$\mathbf{M} = [L, M, N]^T$  – moments of forces vector  $\mathbf{M}$  acting on the airplane

$\mathbf{K} = \sum_i (\mathbf{r}_i \times m_i \mathbf{V}_i)$  – total angular momentum around taken reference point

$\mathbf{M}_{gir} = \mathbf{J}\boldsymbol{\omega} \times \mathbf{\Omega}$  – gyrostatic moment

$\boldsymbol{\omega} = [\omega, 0, 0]^T$  – engine rotor angular velocity vector

$J$  – engine rotor moment of inertia

$C_{Da}, C_{ya}, C_{La}$  – aircraft drag, side and lift coefficients

$C_l, C_m, C_n$  – aircraft roll, pitch, yaw moment coefficients

$b_A$  – mean wing chord

$\rho$  – air density

$l, S$  – wing span and wing area

$t_0, t$  – beginning of icing phenomenon and flight current time

$C_a^{obl}(\alpha, t)$  – aerodynamic coefficient current value of iced airplane

$C_a(\alpha, t_0)$  – aerodynamic coefficient value of non-iced airplane

$\Delta C_a(\alpha, t)$  – change of aerodynamic coefficient value caused by icing

## 1. Introduction

The airplane in-flight icing is a serious problem, still causing many accidents. It can proceed in every climatic zone in foster outer conditions. Usually, the changes of aerodynamic characteristics are so big that the aircrews cannot counteract the icing effects even while using highly efficient onboard anti- and de-icing equipment.

Ice accretion on external airplane components is one of the most dangerous phenomenon which can take place during flight in variable earth atmospheric conditions. It is known since the very beginning of world aviation, but still not fully investigated. Formation of a solid ice cover with different structures and shapes of different speed rates and intensities on airplane external surfaces causes an increase of roughness and overall airplane mass. The process of deformation of an airfoil section of the wing and control surfaces by ice accretion has direct influence on dynamic properties, which cause flow disturbances around the airplane, leading to variation of its dynamic characteristics.

The risk, that is carried during flight in icing conditions, guided many research centers to gain theirs interest in this phenomenon. Conducted studies, theoretical and experimental, are aiming at as close as possible determination of ice accretion influence on aerodynamics and airplane dynamic properties. Investigations made in especially prepared wind tunnels and during test-flights in icing conditions require major staff engagement and big expenses, so that only wealthy research centers can afford it. Because of this, analytical considerations are made using specialized computer codes allowing one to determine

iced airfoils and airplane models aerodynamic characteristics. Nevertheless, this method of scientific research not always shows true airplane dynamic properties during flight in icing conditions, that is why final conclusions must be based on an experimental research conducted on real object flights in weather conditions bringing ice accretion on airplane outer parts.

Ice accretion can form on various airplane external elements. Depending on where firm ice cover appears (f.e. wing, tailplane, fuselage, etc.), the airplane may respond to motion parameters changes and control displacements in different ways as its aerodynamic balance is changing due to in-flight icing. In this research, it is assumed that icing leads to a decrease of aerodynamic lift, increase of aerodynamic drag, pitching moment change, reduction of wing critical angle of attack value. The flap displacement produces a change in flow around horizontal tailplane. Asymmetrical wing icing cause airplane uncontrolled roll (asymmetric of aerodynamic lift) and yaw (asymmetric of aerodynamic drag). These assumptions were specified on the basis of own studies and literature data. Technical data of TS-11 "Iskra" jet trainer were obtained from Rewucki and Sierputowski (2002) and aerodynamics characteristics were derived on the basis of Rley (1998).

## 2. Airplane equations of motion

Spatial motion of the airplane treated as a rigid body is described by a system of twelve nonlinear ordinary differential equations. In practice, engineering calculations employ approximate methods on the basis of computer technology.

There are many external forces and moments of forces acting on the aircraft during flight, which are complex functions of motion parameters as well as geometrical and mass quantities of the investigated object. Additional forces and moments of forces are generated by control surfaces displacements.

The accepted simplifying assumptions:

- airplane is a rigid body with constant mass, constant moment of inertia and invariable position of the centre of mass
- control surfaces are stiff and their axes of rotation have an invariable position against the airplane
- plane  $Oxz$  is a geometrical, mass and aerodynamic symmetry plane.

The gyrostatic moment from revolving jet engine elements is considered in equations of motion.

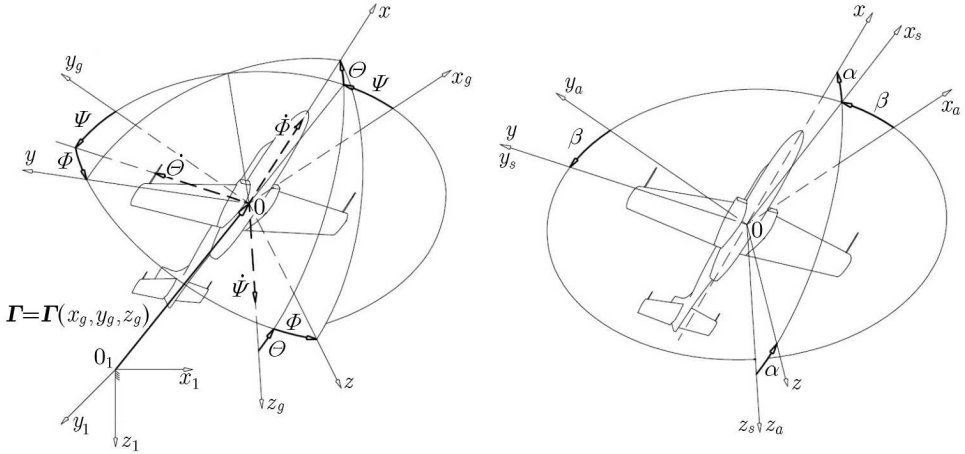

Fig. 1. Systems of coordinates and angles defining its mutual position

The mutual orientation of coordinate systems are defined by following angles: angle of attack  $\alpha$ , angle of slideslip  $\beta$ , aircraft roll angle  $\Phi$ , aircraft pitch angle  $\Theta$ , aircraft yaw angle  $\Psi$ .

Performing rotations successively by Euler angles  $\Psi$ ,  $\Theta$  and  $\Phi$ , a  $Ox_gy_gz_g$  to  $Oxyz$  transition matrix is determined

$$\begin{bmatrix} x \\ y \\ z \end{bmatrix} = \mathbf{A} \begin{bmatrix} x_g \\ y_g \\ z_g \end{bmatrix}$$

where

$$\mathbf{A} = \begin{bmatrix} \cos \Psi \cos \Theta & \sin \Psi \cos \Theta & -\sin \Theta \\ \cos \Psi \sin \Theta \sin \Phi - \sin \Psi \cos \Phi & \sin \Psi \sin \Theta \sin \Phi + \cos \Psi \cos \Phi & \cos \Theta \sin \Phi \\ \cos \Psi \sin \Theta \cos \Phi + \sin \Psi \sin \Phi & \sin \Psi \sin \Theta \cos \Phi - \cos \Psi \sin \Phi & \cos \Theta \cos \Phi \end{bmatrix}$$

Performing rotations by  $-\beta$  and  $\alpha$  angles, a  $Ox_a y_a z_a$  to  $Oxyz$  transition matrix is determined

$$\begin{bmatrix} x \\ y \\ z \end{bmatrix} = \begin{bmatrix} \cos \alpha \cos \beta & -\cos \alpha \sin \beta & -\sin \alpha \\ \sin \beta & \cos \beta & 0 \\ \sin \alpha \cos \beta & -\sin \alpha \sin \beta & \cos \alpha \end{bmatrix} \begin{bmatrix} x_a \\ y_a \\ z_a \end{bmatrix}$$

## 2.1. Airplane translational equations of motion

Vector equation of motion of the centre of mass

$$m \frac{d\mathbf{V}}{dt} = \mathbf{F} \quad (2.1)$$

and it can be written in a scalar form in the airplane fixed system of coordinates  $Oxyz$

$$\begin{aligned} m(\dot{u} + qw - rv) &= X & m(\dot{v} + ru - pw) &= Y \\ m(\dot{w} + pv - qu) &= Z \end{aligned} \quad (2.2)$$

Using transformations in Kowaleczko (2003) and Wachłaczhenko (2010), the airplane translational equations of motion are obtained

$$\begin{aligned} \dot{V} &= \frac{1}{m}(X_s \cos \beta + Y_s \sin \beta) \\ \dot{\alpha} &= \frac{1}{\cos \beta - \frac{Z_s^{\dot{\alpha}}}{mV}} \left[ \frac{Z_{Sst}}{mV} + q \cos \beta - (p \cos \alpha + r \sin \alpha) \sin \beta \right] \\ \dot{\beta} &= \frac{1}{mV}(Y_s \cos \beta - X_s \sin \beta) + p \sin \alpha - r \cos \alpha \end{aligned} \quad (2.3)$$

Equation (2.2) considers that the aerodynamic force  $P_{za}$  as a part of force  $Z_a$  depends, among other things, on the rate of change of the airplane angle of attack. So, it is calculated as follows

$$Z_a = Z_{ast} + Z_a^{\dot{\alpha}} \dot{\alpha} \quad (2.4)$$

## 2.2. Airplane rotary equations of motion

The vector equation of the total angular momentum change

$$\frac{d\mathbf{K}}{dt} = \mathbf{M} + \mathbf{M}_{gir} \quad (2.5)$$

Because the  $Oxz$  surface is the airplane geometrical, mass and aerodynamic symmetry plane and the engine rotor rotates with an angular velocity  $\omega$  along axis parallel to airplane axis  $Ox$ , the scalar form of equation (2.5) in the airplane fixed system of coordinates  $Oxyz$  is

$$\begin{aligned} I_x \dot{p} - (I_y - I_z)qr - I_{xz}(\dot{r} + pq) &= L \\ I_y \dot{q} - (I_z - I_x)pr - I_{xz}(r^2 - p^2) &= M - J\omega r \\ I_z \dot{r} - (I_x - I_y)pq - I_{xz}(\dot{p} - qr) &= N + J\omega q \end{aligned} \quad (2.6)$$

Converting system (2.6) (Kowaleczko, 2003)

$$\begin{aligned}
 \dot{p} &= \frac{1}{I_X I_Z - I_{XZ}^2} \left\{ [L + (I_Y - I_Z)qr + I_{XZ}pq]I_Z \right. \\
 &\quad \left. + [N + J\omega q + (I_X - I_Y)pq - I_{XZ}qr]I_{XZ} \right\} \\
 \dot{q} &= \frac{1}{I_Y} [M - J\omega r + (I_Z - I_X)rp + I_{XZ}(r^2 - p^2)] \\
 \dot{r} &= \frac{1}{I_X I_Z - I_{XZ}^2} \left\{ [L + (I_Y - I_Z)qr + I_{XZ}pq]I_{XZ} \right. \\
 &\quad \left. + [N + J\omega q + (I_X - I_Y)pq - I_{XZ}qr]I_X \right\}
 \end{aligned} \tag{2.7}$$

Moreover, to equations (2.3) and (2.7) we still need to add equations defining the current mass centre angular position (Euler angles, the kinematic relations) (2.8) and equations determining airplane centre of mass position components in gravitational system of coordinates  $Ox_g y_g z_g$  (2.9)

$$\begin{aligned}
 \dot{\Phi} &= p + (r \cos \Phi + q \sin \Phi) \tan \Theta & \dot{\Theta} &= q \cos \Phi - r \sin \Phi \\
 \dot{\Psi} &= (r \cos \Phi + q \sin \Phi) \frac{1}{\cos \Theta}
 \end{aligned} \tag{2.8}$$

and

$$\begin{aligned}
 \dot{x}_g &= V[\cos \alpha \cos \beta \cos \Theta \cos \Psi + \sin \beta(\sin \Phi \sin \Theta \cos \Psi - \cos \Phi \sin \Psi) \\
 &\quad + \sin \alpha \cos \beta(\cos \Phi \sin \Theta \cos \Psi + \sin \Phi \sin \Psi)] \\
 \dot{y}_g &= V[\cos \alpha \cos \beta \cos \Theta \sin \Psi + \sin \beta(\sin \Phi \sin \Theta \sin \Psi + \cos \Phi \cos \Psi) \\
 &\quad + \sin \alpha \cos \beta(\cos \Phi \sin \Theta \sin \Psi - \sin \Phi \cos \Psi)] \\
 \dot{z}_g &= V(-\cos \alpha \cos \beta \sin \Theta + \sin \beta \sin \Phi \cos \Theta + \sin \alpha \cos \beta \cos \Phi \cos \Theta)
 \end{aligned} \tag{2.9}$$

Equations (2.3), (2.7), (2.8) and (2.9) form a system of twelve nonlinear ordinary differential equations describing the airplane spatial motion considered as a rigid body with a constant mass. The motion parameters vector has the following components:  $V, \alpha, \beta, p, q, r, \Phi, \Theta, \Psi, x_g, y_g, z_g$ .

### 3. Forces and moments acting on the airplane

The vector of external forces which are affecting the airplane (right-hand side of equation (2.1)) may be written as

$$\mathbf{F} = \mathbf{Q} + \mathbf{T} + \mathbf{R} \tag{3.1}$$

The airplane gravitational force  $\mathbf{Q}$  in the  $Ox_gy_gz_g$  system has only one component  $\mathbf{Q} = [0, 0, mg]^\top$ . In  $Ox_a y_a z_a$  system

$$\begin{aligned} Q_{x_a} &= mg(-\cos \alpha \cos \beta \sin \Theta + \sin \beta \cos \Theta \sin \Phi + \sin \alpha \cos \beta \cos \Theta \cos \Phi) \\ Q_{y_a} &= mg(\cos \alpha \sin \beta \sin \Theta + \cos \beta \cos \Theta \sin \Phi - \sin \alpha \sin \beta \cos \Theta \cos \Phi) \\ Q_{z_a} &= mg(\sin \alpha \sin \Theta + \cos \alpha \cos \Theta \cos \Phi) \end{aligned} \quad (3.2)$$

The engine thrust vector  $\mathbf{T}$  lies in the airplane symmetry plane  $Oxz$  and it is parallel to  $Ox$  axis and placed in the airplane mass centre, so that in  $Oxyz$  system

$$\mathbf{T} = [T, 0, 0]^\top \quad (3.3)$$

In the flow system of coordinates

$$T_{x_a} = T \cos \alpha \cos \beta \quad T_{y_a} = -T \cos \alpha \sin \beta \quad T_{z_a} = -T \sin \alpha \quad (3.4)$$

The resultant aerodynamic  $R$  force projections on the  $Ox_a y_a z_a$  system axes and the moment vector  $\mathbf{M} = [L, M, N]^\top$  on the right-hand side of equation (2.5) is the resultant moment acting on the airplane

$$\begin{aligned} R_{x_a} = -P_{x_a} &= -C_{Da} \frac{\rho V^2}{2} S & L &= C_l \frac{\rho V^2}{2} S b_A \\ R_{y_a} = -P_{y_a} &= -C_{ya} \frac{\rho V^2}{2} S & M &= C_m \frac{\rho V^2}{2} S b_A \\ R_{z_a} = -P_{z_a} &= -C_{La} \frac{\rho V^2}{2} S & N &= C_n \frac{\rho V^2}{2} S l \end{aligned} \quad (3.5)$$

#### 4. Initial flight conditions

At the beginning of simulation, the airplane performs a rectilinear steady flight with a given constant speed. For this condition, we can take

$$p = q = r = 0 \quad \beta = 0 \quad \Phi = 0 \quad \gamma = \Theta - \alpha = 0$$

and

$$\dot{V} = \dot{\alpha} = \dot{\beta} = \dot{p} = \dot{q} = \dot{r} = \dot{\Theta} = \dot{\Phi} = 0$$

To perform a flight in these conditions, the resultant force and moment acting on the airplane must be equal to zero

$$P_{Da} \sin \alpha + (P_{La} - mg) \cos \alpha = 0 \quad T - P_{Da} \cos \alpha + (P_{La} - mg) \sin \alpha = 0 \quad (4.1)$$

Transformations of the above equations allow one to obtain a steady flight angle of attack  $\alpha$  (4.1)<sub>1</sub> and indispensable thrust  $T$  (4.1)<sub>2</sub>. The known airplane angle of attack  $\alpha$  permits one to set the elevator displacement angle  $\delta_{H0}$  (4.2), so as the pitching moment coefficient has to be equal to zero

$$C_m = C_{mst}(V, \alpha) + \frac{\partial C_m}{\partial \delta_H} \delta_{H0} = 0 \quad \delta_{H0} = -\frac{C_{mst}}{\frac{\partial C_m}{\partial \delta_H}} \quad (4.2)$$

## 5. Aerodynamic force and moment coefficients

The experimentally obtained airplane static aerodynamic characteristics of drag  $C_{Da}(\alpha, Ma)$ , lift  $C_{La}(\alpha, Ma)$  and pitch  $C_m(\alpha, Ma)$  are used in this paper. Along with the determined dynamic derivatives, this allows one to set final expressions defining the force and moment coefficients:

– drag force:	$C_{Da} = C_{Da}(\alpha, Ma)$
– side force:	$C_{ya} = C_{ya}^\beta \beta + C_{ya}^p p + C_{ya}^r r + C_{ya}^{\delta_V} \delta_V + C_{ya}^{\delta_l} \delta_l$
– lift force:	$C_{La} = C_{La}(\alpha, Ma) + C_{La}^\alpha \dot{\alpha} + C_{La}^q q + C_{La}^{\delta_H} \delta_H$
– rolling moment:	$C_l = C_l^\beta \beta + C_l^p p + C_l^r r + C_l^{\delta_V} \delta_V + C_l^{\delta_l} \delta_l$
– pitching moment:	$C_m = C_m(\alpha, Ma) + C_m^\alpha \dot{\alpha} + C_m^q q + C_m^{\delta_H} \delta_H$
– yawing moment:	$C_n = C_n^\beta \beta + C_n^p p + C_n^r r + C_n^{\delta_V} \delta_V + C_n^{\delta_l} \delta_l$

## 6. Airplane ice accretion effects modeling

Nowadays, there are many numerical models employed to conduct studies about the aircraft surface ice accretion influence on aerodynamic characteristics and dynamic parameters. The computer code using equations of motion and their numerical integration allows one to study the object movement under the icing conditions in any given ice accretion models.

The in-flight icing causes flow distortion around the lift and control surfaces, and produces considerable forces and moments of forces changes during flight. The change of airfoil geometry results in:

- increase of aerodynamic drag (up to hundreds of percent) due to greater airplane surfaces roughness
- decrease of the aerodynamic lift maximum value  $C_{Lmax}$
- decrease of the critical angle of attack value  $\alpha_{cr}$



- decrease of the  $dC_{La}/d\alpha$  derivative value
- increase of the stall speed
- additional pitching moment arising
- asymmetric wing icing leads to uncontrolled airplane rolling and yawing.

The assumption of this paper is that the relative value of the aerodynamic coefficient of forces and moments of forces is changing as in Fig. 2. The studies on the aircraft icing caused that in the numerical modeling, only the wing lift, drag and pitch coefficients changes are taken under consideration in the computer codes.

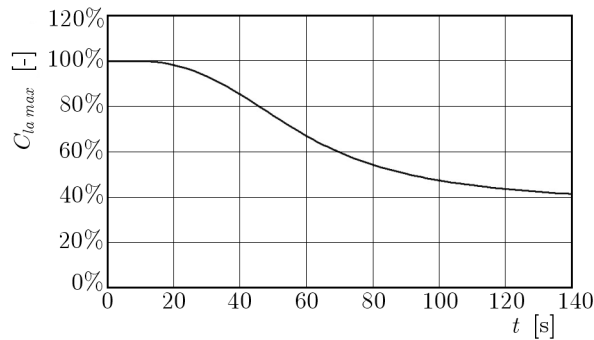

Fig. 2. Aircraft maximum lift coefficient relative change as a function of time

The aerodynamic coefficients change as follows

$$C_a^{obl}(\alpha, t) = C_a(\alpha, t_0) - \Delta C_a(\alpha, t) \quad (6.1)$$

where  $\Delta C_a$  denote the lift, drag and pitch coefficient, and they are functions of the airplane angle of attack and time (mathematical function elaborated by Wachłaczzenko, beyond the scope of this paper).

This model of airplane icing phenomenon does not include the total weight change (negligible increase, about 1.1% of clean airplane weight) and the displacement of mass centre (shift less then 0.01 m) during flight in icing conditions. The moments of inertia and moments of deviation are constant as well.

To study the influence of aircraft icing on the dynamic properties, using a computer code to determine flight parameters, different cases of aerodynamic coefficients change can be implemented. The majority of scientific publications about airplane icing and its effect refer to decrease of critical angle of attack as well as aerodynamic lift, increase of total mass and aerodynamic drag. The

change of mass can be taken under account depending on the complexity of the used computer code determining iced airplane flight parameters, but the increase of total weight caused by ice accretion is only about few percent. The in-flight icing causes an aircraft balance change, hence the pitching moment coefficient alteration is taken under consideration.

Iced airplane aerodynamic force and moment of force coefficient measurements in especially prepared wind tunnels prove that in all cases the aerodynamic drag increases. It is caused by ice accretion on lifting surfaces, tailplane, fuselage and other airplane external equipment. The lift coefficient decreases depending on the type and shape of the ice cover on the wing, but it can also increase slightly.

In the computer code which determines aircraft flight parameters, the aerodynamic coefficient change model is used (on the basis of equation (6.1)):

- wing drag coefficient (Fig. 3):  $C_{Da}^{obl}(\alpha, t) = C_{Da}(\alpha, t_0) + \Delta C_{Da}(\alpha, t)$
- wing lift coefficient (Fig. 4):  $C_{La}^{obl}(\alpha, t) = C_{La}(\alpha, t_0) - \Delta C_{La}(\alpha, t)$
- wing pitch coefficient (Fig. 5):  $C_m^{obl}(\alpha, t) = C_m(\alpha, t_0) - \Delta C_m(\alpha, t)$

The manner of pitching moment coefficient change is based on a very few experimental data, which the authors could find in the available literature.

Figures 3-5 show the changes of airplane lift, drag, pitch coefficient alterations during ice-accretion simulations:

- no ice  $t < 10$  s
- - - - - iced wing  $t = (10 + 30)$  s
- - - - - iced wing  $t = (10 + 60)$  s

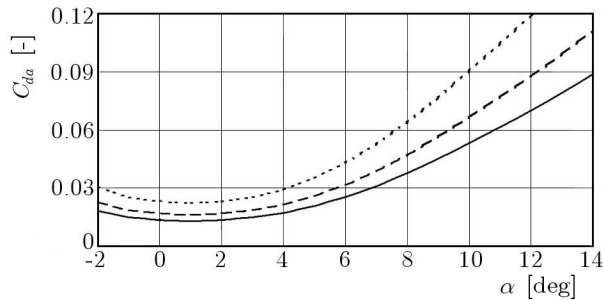

Fig. 3. Airplane drag coefficient

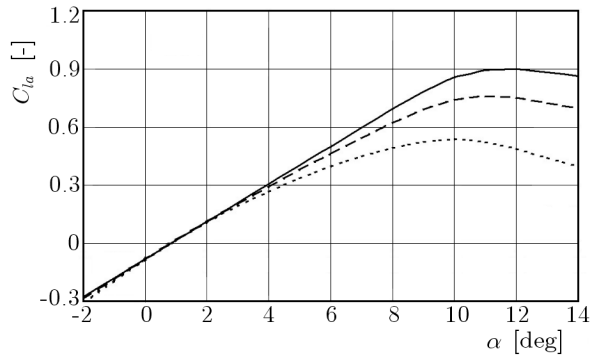

Fig. 4. Airplane lift coefficient

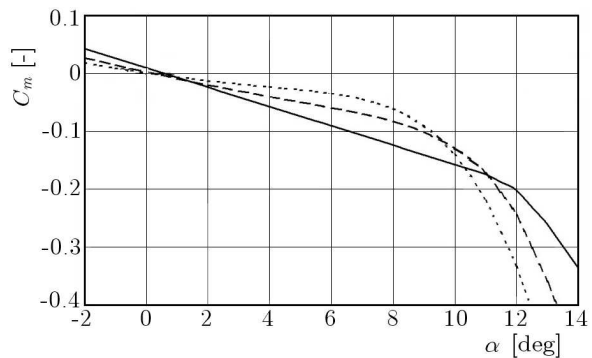

Fig. 5. Airplane pitch coefficient

## 7. Aircraft in-flight icing analysis

The initial condition is a steady flight. Depending on the calculation variant, it was a rectilinear flight (case a – solid line) and steady descent (case b – dot line) with velocity of 90 m/s (324 km/h,  $Ma \approx 0.265$ ) on altitude equal to 1000 m. The airplane is performing flight in a smooth configuration (flaps on  $\delta_{KL} = 0^\circ$ ). The jet engine thrust was determined on the base of steady flight condition (equation (4.1)<sub>2</sub>) and remains constant in the analysed time interval. The static pitching moment is compensated by the horizontal control surface deflection (equation (4.2)). The system of twelve nonlinear ordinary differential equations (equations (2.3), (2.7)-(2.9)) and the wing icing model was used to perform the analysis.

The calculations were carried for 200 seconds of flight. The in-flight icing phenomenon occurs in the 10th second of flight. There is no pilot's response, so the airplane behaviour is investigated.

The symmetric wing icing starts in the 10th second of linear steady flight. The extra positive pitching moment (Fig. 5) caused by ice accretion creates a slow increase in the airplane altitude (Fig. 10). The airplane angle of attack (Fig. 7) increases as well, and it approaches to its critical value which is lower than for a non-iced airplane. The temporary climb produces the loss of speed (Fig. 6).

After 50 seconds of flight, airplane has not got enough lift to continue the climb and begins to descend with a velocity increase. The angle of attack is maintained in the range of 8.0-8.5 degrees.

Similar calculations were conducted for the initial descent case. In all the above mentioned events, the changes were alike. They only differ in the maximum values of flight parameters.

Figure 10 shows that in about two minutes from the start of the icing phenomenon, the airplane reaches zero altitude performing the right turn and deviating about 250 meters from the initial direction.

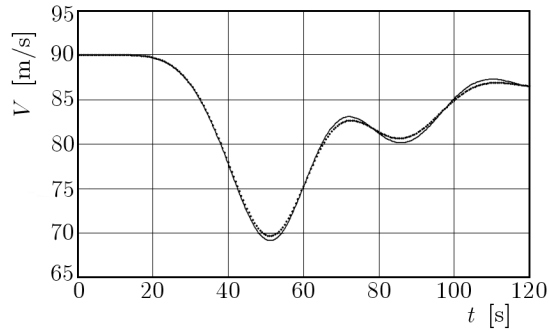

Fig. 6. Airplane total velocity

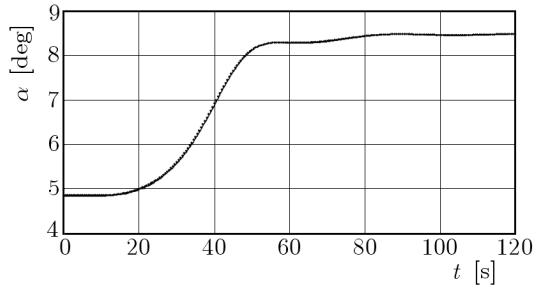

Fig. 7. Airplane angle of attack

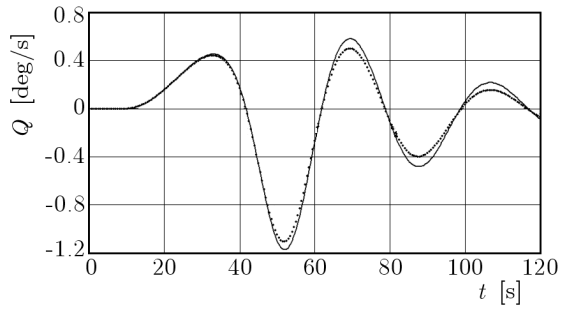

Fig. 8. Airplane pitching angular velocity

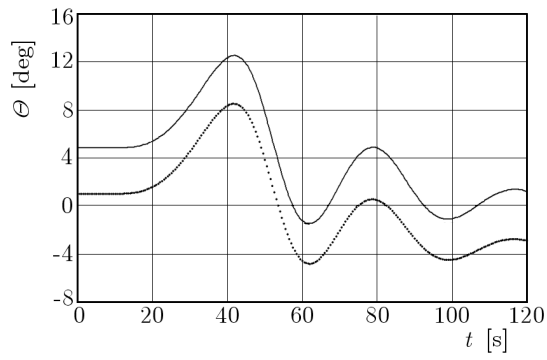

Fig. 9. Airplane angle of pitch

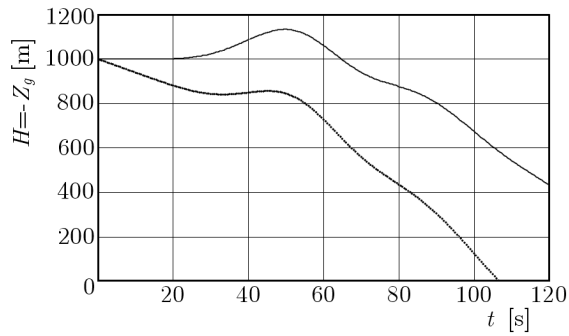

Fig. 10. Airplane flight altitude

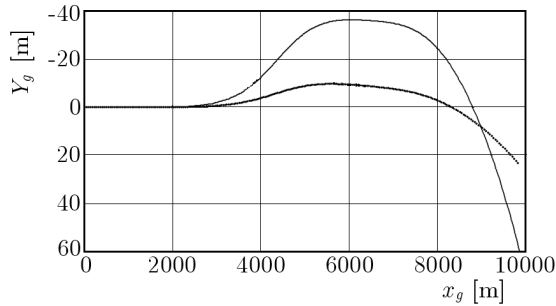

Fig. 11. Airplane trajectory projection on the ground plane

## 8. Conclusions

The icing phenomenon is especially dangerous during takeoff and landing. Low velocity, high angles of attack close to its critical value, in such flight conditions the changes of aerodynamic lift generated by icing are the most considerable.

The conducted analysis provide following conclusions of aircrew performing flights in icing conditions:

- on the basis of meteorological information try to pass round the icing zone, in the case of entering – immediately leave icing zone
- if there is a huge pitching moment while displacing the flaps, they must be put in the previous position or fully hidden.

If the in-flight icing on lifting or control surfaces occurs, the autopilot must be disabled (negligible changes of airplane dynamics would be leveled by autopilot and the aircrew would be unable to notice these changes as a result of possible icing). During the process of removing the ice cover from lifting surfaces by onboard deicing equipment, the process must be observed constantly, non-uniform tearing off of the ice cap can cause asymmetry of forces on the wing leading to uncontrolled airplane rolling and yawing.

## References

1. AL-SHARABI M., MARYNIAK J., 2002, Wyznaczanie charakterystyk aerodynamicznych oblodzonego samolotu, [In:] *Mechanika w Lotnictwie, ML-X*, J. Maryniak (Edit.), 121-134

2. BJÖRK Å., DAHLQUIST G., 1983, *Metody numeryczne*, PWN, Warszawa
3. CEBECI T., 1995, Effect of ice on airfoil stall at high Reynolds numbers, *AIAA Journal*, **33**, 7, 1351-1352
4. DŻYGADŁO Z., KOWALECZKO G., SIBILSKI K., 2001, *Charakterystyki aerodynamiczne samolotu ze skrzydłem pasmowym i jego ruchy własne*, Prace Instytutu Lotnictwa, Warszawa
5. FISZDON W., 1962, *Mechanika lotu Cz. I*, PWN, Warszawa
6. FISZDON W., 1962, *Mechanika lotu Cz. II*, PWN, Warszawa
7. FRANT M., KOWALECZKO G., SOBIERAJ W., 2002, *Doświadczalne charakterystyki profilu lotniczego z modelowanym oblodzeniem*, Prace Instytutu Lotnictwa, Warszawa
8. GUTOWSKI R., 1971, *Równania różniczkowe zwyczajne*, WNT, Warszawa
9. HERSI I., MARYNIAK J., 1993, *Symulacja numeryczna wpływu oblodzenia powierzchni nośnych samolotu na charakterystyki aerodynamiczne i parametry dynamiczne*, Prace Instytutu Lotnictwa, Warszawa
10. KOCHAŃSKI A., 1938, *Obladzanie samolotów*, Lwów
11. KOWALECZKO G., 2003, *Zagadnienie odwrotne w dynamice lotu statków powietrznych*, Wydawnictwo WAT, Warszawa
12. KOWALECZKO G., SOBIERAJ W., 2002, Wpływ oblodzenia na charakterystyki lotne statków powietrznych, [In:] *Mechanika w Lotnictwie, ML-X*, J. Maryniak (Edit.), 87-112
13. KRZYŻANOWSKI A., 1984, *Mechanika lotu*, Skrypt WAT, Warszawa
14. MARYNIAK J., WOJCIECHOWSKI Z., 2002, Wpływ oblodzenia na charakterystyki aerodynamiczne wybranych modeli samolotów, [In:] *Mechanika w Lotnictwie, ML-X*, J. Maryniak (Edit.), 113-120
15. OSTOŚLAWSKIJ N.W., 1957, *Aerodinamika samoleta*, Oborongizdat, Moskwa
16. Praca Zbiorowa, 1981, *Wyniki badań tunelowych samolotu TS-11 „Iskra”*, Opracowanie wewnętrzne ITL WAT, WAT, Warszawa
17. REWUCKI P., SIERPUTOWSKI P., 2002, Struktury oblodzenia skrzydła samolotu oraz ich wpływ na charakterystyki aerodynamiczne, [In:] *Mechanika w Lotnictwie, ML-X*, J. Maryniak (Edit.), 189-202
18. RILEY J.T., 1998, *Mixed-Phase Icing Conditions: A Review*, Office of Aviation Research, Washington DC
19. WACHŁACZENKO M., 2010, The influence of wing transverse vibration on dynamic parameters of an aircraft, *Journal of Theoretical and Applied Mechanics*, **48**, 2, 397-413

## Parametry lotu samolotu w warunkach oblodzenia

### Streszczenie

Praca przedstawia wyniki numerycznej analizy parametrów ruchu samolotu podczas symetrycznego oblodzenia skrzydła oraz usterzenia wysokości w czasie lotu. Pod uwagę wzięto również przypadek wypuszczania klap zaskrzydłowych w czasie występowania oblodzenia. Zastosowano klasyczny model matematyczny dynamiki ruchu samolotu, opisany przez układ dwunastu równań różniczkowych pierwszego rzędu. W odniesieniu do wiadomości zaczerpniętych z literatury oraz danych geometryczno-masowych samolotu TS-11 „Iskra” opracowano program komputerowy do wyznaczania parametrów ruchu z uwzględnieniem oblodzenia samolotu. Na podstawie analizy wyników przedstawiono wnioski opisujące własności dynamiczne samolotu wykonującego lot w warunkach oblodzenia.

*Manuscript received January 14, 2010; accepted for print June 15, 2011*