

# VIBRATION CONTROL OF A GANTRY CRANE SYSTEM USING DYNAMIC FEEDBACK SWING CONTROLLER

Azdiana<sup>1</sup>, Noor Asyikin<sup>1</sup>, Sharatul Izah<sup>1</sup>, Nur Alisa<sup>1</sup>

<sup>1</sup>Faculty of Electronics Engineering and Computer Engineering,  
Universiti Teknikal Malaysia Melaka, Locked Bag 1752,  
Pejabat Pos Durian Tunggal, 76109 Durian Tunggal, Melaka.

## ABSTRACT

*The use of gantry crane system for transporting payload is very common in industrial application. However, moving the payload using the crane is not easy task especially when strict specifications on the swing angle and on the transfer time need to be satisfied. To overcome this problem a dynamic feedback swing controller is designed for the gantry position and speed, as well as the load angle and angular velocity using PID controller. Simulated responses of the position of the trolley and sway angle of the mass are presented using MATLAB. The performance of the Bang-bang torque input function and the feedback swing controller are compared. From the simulation results, satisfactory vibration reduction of a crane system has been achieved using the proposed method.*

*KEYWORDS: PID controller, Dynamic feedback swing controller, gantry crane system*

## 1.0 INTRODUCTION

A gantry crane system is a crane carrying the trolley or trolley with a movable or fixed hoisting mechanism, that the bridge is rigidly supported on two or more legs running on fixed rails or other runway. The fundamental motions of a gantry crane consist of traversing, load hosting and load lowering. Like other crane types, gantry cranes met with some dissatisfaction due to its natural characteristics. Nowadays, industrial uses gantry crane to transfer the loads but not too safety because of the load always swing and might be any incident occurs. The operator, by skillful manual drive of the gantry controls, ensures that this unavoidable pendulum motion subsides as quickly as possible, since extended loading and unloading time costly.

As mentioned, the fundamental motions of a gantry crane consist of traversing, load hosting and load lowering. These significant characteristic is that all motions are performed simultaneous at relatively high speed. Crane traversing motions, particularly when starting or stopping; induce undesirable swinging of the suspended load. This creates another problem that the swing could cause the hosting rope to leave its groove which could lead to over wrapping and damage. One of the characteristics of these cranes is the flexible hoisting ropes used as a part of the structure for the reduction of system mass, which result in favorable features of high payload ratio, high motion speed and low power consumption. However, the flexible hoisting create serious problems, that is the crane acceleration which required for motion will generate undesirable load swing, which is frequently aggravated by load hoisting. Therefore, such load swing should be suppressed as rapidly as possible to maximize the operations.

Several methods of open-loop and closed-loop solutions have been proposed in order to control the vibration. For example, open loop time optimal strategies were applied to the crane by many researchers such as discussed in [G.A. Manson,1992]. They came out with poor results because open loop strategy is sensitive to the system parameters (e.g. rope length) and could not compensate for wind disturbances [Wahyudi and J. Jalani, 2005]. The most popular technique for input shaping is to convolve a sequence of impulses and various methods for shaping impulse sequence of impulses have been testified and applied to crane system as in [J.K. Cho and Y. S. Park, 1995]. M N Sahinkaya in his paper [M.N. Sahinkaya, 2001] also has reported the same inverse dynamic technique in spring-mass-damper system. However all the above method is still an open-loop approach that avoid the system from become less sensitive to disturbances.

Increasingly however, feedback control which is well known to be less sensitive to disturbances and parameter variations also adopted to control the gantry crane system. Work that has been presented by Omar [H.M. Omar, 2003] had proposed PD (Proportional-Derivative) controllers for both position and anti-swing controls. Moreover, a Fuzzy Logic Controller had been introduced by Wahyudi and Jamaludin [Wahyudi and J. Jalani, 2005]. Fuzzy logic controllers were designed and implemented for controlling payload position as well as the swing angle of the gantry crane.

This paper will focus on a feedback control system based on the dynamic model of the gantry crane system. The main idea is to produce vibration free system using PID as a controller algorithm. The improvement of the output response will be investigated by comparing the dynamic feedback swing controller and bang-bang torque input function.

## **2.0 MODELLING OF A GANTRY CRANE SYSTEM**

This section will emphasize on the modelling of a gantry crane that includes certain assumptions to make the design more sustainable. The model of a gantry crane is shown in Figure 1. Generally, the configuration of the gantry crane model is specified by the horizontal position of the trolley,  $x$ , the length of the hosting rope,  $l$ , and the swing angle of the rope,  $\theta$ . The payload, which is suspended from the point of suspension,  $S$ , is assumed to be a rigid body symmetric about its axis with mass  $m$  and centre point,  $G$  of mass  $m$ .

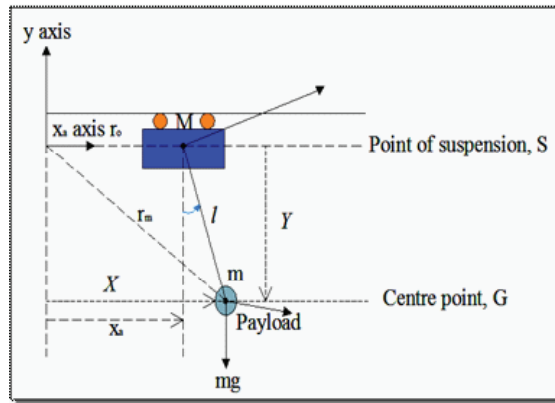

FIGURE 1  
Model of a gantry crane

Before the derivation of the equations of motion, some assumptions are made for simplicity. Firstly, friction force that may exist in the trolley is ignored. The trolley and the payload can be considered as point masses. Besides, the tension force that may cause the hoisting rope elongate is also neglected. The trolley and the payload are assumed to move in x-y plane, which means a study of two dimensional.

For the dynamic behaviors of the gantry crane model, the centre point G and the position vector of point of suspension, S with respected to the fixed axes coordinate have to be determined.

The position of the load is given by:

$$X = x_s + l \sin \theta \tag{1}$$

$$Y = l \cos \theta \tag{2}$$

Based on the above assumptions, the equations of motion for the gantry crane system depicted in Figure 1 are derived as follows.

$$x : F_x = (M + m)\ddot{x} + ml(\ddot{\theta} \cos \theta - \dot{\theta}^2 \sin \theta) + 2m\dot{\theta} \cos \theta + m\ddot{l} \sin \theta \tag{3}$$

$$\theta : l\ddot{\theta} + 2\dot{l}\dot{\theta} + \ddot{x} \cos \theta + g \sin \theta = 0 \tag{4}$$

$$l : F_l = m\ddot{l} + m\ddot{x} \sin \theta - ml\dot{\theta}^2 \cos \theta \tag{5}$$

After linearization, then equation of motion of the gantry crane becomes:

$$x : F_x = (M + m)\ddot{x} + ml\ddot{\theta} \tag{6}$$

$$\theta : l\ddot{\theta} + \ddot{x} + g\theta = 0 \tag{7}$$

$$l : F_l = m\ddot{x} - mg \tag{8}$$

Generally,  $\theta$  is very small of its value. This makes . This suggests that the hoisting motion of the gantry crane is decoupled from the trolley if such approximation is

made.

### **3.0 DYNAMIC FEEDBACK SWING CONTROLLER**

Dynamic refers to the motion of the trolley as induced by internal forces and external forces. Internal forces include the gravity forces while the external forces include the applied force, normal force, tension force, friction force, and air resistance force. Some of these forces are shown in Figure 1.

Feedback is the path that leads from the initial generation of the feedback signal to the subsequent modification of the system. It means for this system, the initial generation is unstable. So, to overcome this problem it needs to be modified so that the system achieves a stable system. Gains are determined to complete this feedback for gantry crane system.

Whereas, swing control refers to payload that carried by the trolley. The trolley is controlled with feedback system to ensure minimal swing of payload. This method able to control the swing of payload until the trolley reaches target position without vibration. By conclusion, dynamic feedback swing control means the trolley moves along the track with internal forces and external forces from the initial generation of the feedback signal to the subsequent modification of the system by controlling the swing of payload to reduce vibration.

Dynamic feedback swing control is a method used to drive a system of gantry crane uncertain mass from initial position to a target position as quickly, accurately and safely as possible without vibration by reducing the sway angle of payload. This dynamic feedback is designed by using PID controller. The value of certain system parameters such as rope length and payload mass may significantly during the operation. This project will focus on closed loop control system where a dynamic model is designed by using SIMULINK in the MATLAB software. It will be analyzed by referring to the derivation of the dynamic feedback input function.

The first step to design PID controller is to determine the type of controller whether SISO type or MIMO type. SISO type also known as Single Input Single Output while MIMO is known as Multiple Input Multiple Output. Based on the plant of gantry crane, two forces are needed to move the trolley until it reach target position (1 meter) without vibration. It means two inputs and two outputs are considered in order to reduce the vibration. So, this cascade PID controller design is called as MIMO type controller.

Since it is a MIMO type controller, the output needs to be determined whether it should be placed as inner loop or outer loop. Sway angle is defined as inner loop while trolley position as outer loop. The sway angle is set up as inner loop because its output response is easier to change compared to output response of trolley position. Figure 2 shows the inner loop and outer loop for this response.

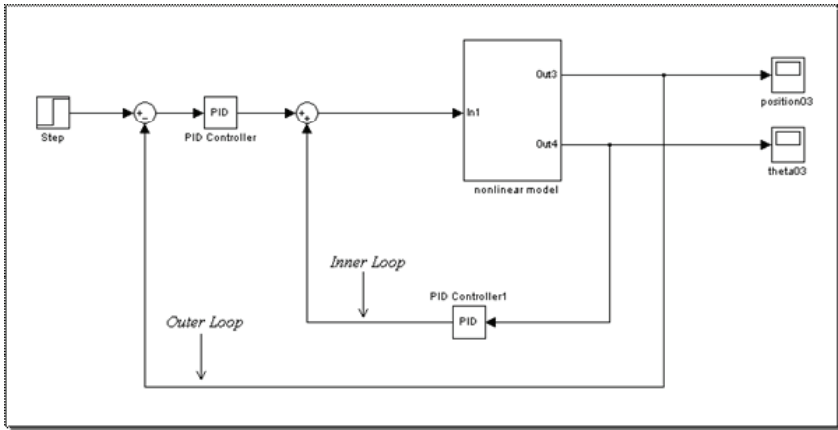

FIGURE 2  
Inner loop and outer loop

Both outputs can be controlled by using PID tuning based on process response. When a process response rapidly change in the manipulate variable, tuning can be determined by observing the response to change in controller parameters. In general the parameters are tuned in order proportional ( $K_p$ ), integral ( $T_i$ ), derivative ( $T_d$ ). Each parameter is increased until a sustained oscillation is observed in process variable response.

#### 4.0 RESULTS AND ANALYSIS

In this work, the following gantry crane parameters are used. The parameters correspond to the experimental crane system presented by Yong-Seok Kim, Han-suk Seo and Seung-Ki in [Y.S. Kim et al., 2001]. System.

- i. Trolley mass,  $M=1$  kg
- ii. Payload mass,  $m=0.8$  kg
- iii. Length of the hoisting rope,  $l=0.305$  meter

A comparison with input shaping technique has been executed in order to prove the effectiveness of the approach presented in this paper. The dynamic feedback swing controller has been compared with the bang-bang torque input function that is assumed to be 1.8 Nm.

Figures 3 and 4 show the sway motion of the payload when an input force is applied to the trolley. The motion of the payload is a pendulum like motion where the payload will swing from its initial position to a final position. By definition, the initial position has an angle of zero. When the input force is positive, as shown in Figure 3, the sway angle will be a negative value, which swings clockwise by definition. Vice versa, when the applied force is negative, the sway angle, which swings anticlockwise, will be positive in value, as shown in Figure 4. From the perspective of the transformation of energy, the initial position point has a maximum value of kinetic energy whereas the final position point has the maximum potential energy.

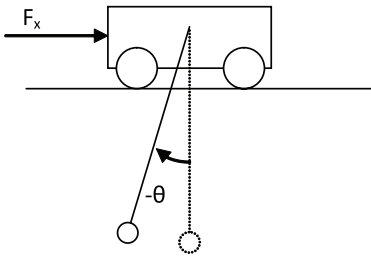

FIGURE 4

Sway motion when input force is positive

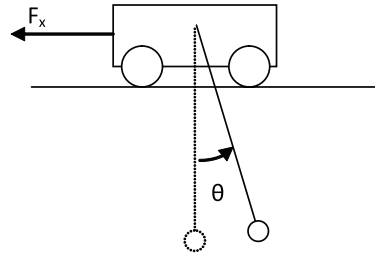

FIGURE 4

Sway motion when input force is negative

From the following simulation results in Figure 6, which the bang-bang torque input function is applied to the trolley, it can be seen that the sway angle in radian have a trend related to the applied force directions. However, when the applied force is taken off ( $F_x = 0N$ ), it is found that the load still oscillate and is having a large oscillation. This result indicates that the payload motion has a very significant response to acceleration or deceleration commands without any feedback control.

It is noted that the motion of the payload is affected by the applied force which it will swing according to its path defined earlier. In bang-bang torque input function, the payload continues to oscillate although the force is taken off by the time 2 seconds. The payload oscillates with a maximum value 0.28 radian, which is approximately 16.04 degree from its initial position. This value is become significant when the length of hoisting rope become larger. This is due to the chord length, which is nearly equal to the arc length that proportionally increases with the length of the hoisting rope as illustrated in Figure 5.

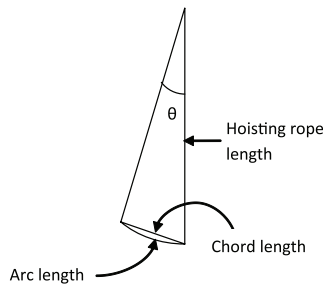

FIGURE 5

Arc length and chord length

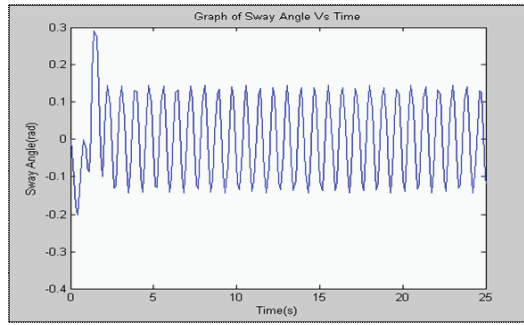

FIGURE 6

Payload sway angle by using bang-bang torque input function

Thus, from the simulation result in Figure 6, the 0.28 radian will create a 8.4 cm chord length, which is considered as a large swing in this case. For industrial use gantry crane, this will cause nearly 1 meter chord length which will create safety problems and damages to the surrounding environment.

Hence, by using dynamic feedback swing controller adopted in Figure 7, the payload stops oscillate with no vibration. It will not create any chord length, resulting the vibration reduction of sway angle in this technique is 100% compared to bang-bang torque input function. Table 1 shows the summary results of the sway angle of the payload by using both techniques.

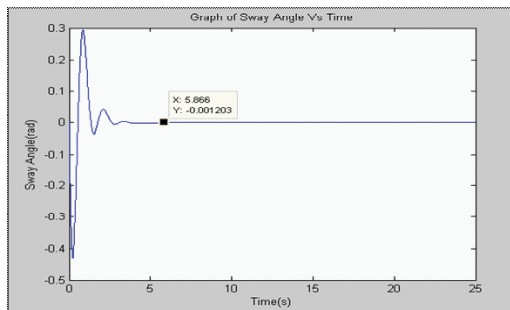

FIGURE 7

Payload sway angle by using dynamic feedback swing controller

TABLE 1  
Sway Angle of the Hoisting Rope

Performance	Bang-Bang Torque Input Function	Dynamic Feedback Swing Controller
Sway Angle (rad)	0.28	0
Sway Angle (°)	16.04	0

The simulation results of the positioning of the trolley with the bang-bang torque input function and dynamic feedback swing controller are shown in Figure 8 and Figure 9 respectively. From the simulation results, it can be clearly seen that the vibration occur when using bang-bang torque input function. It reaches about 1.22 meter at 2 seconds.

The dynamic feedback swing controller provides no vibration during positioning the trolley along its path and reach 1 meter at 7.4 seconds where the force is taken off. This is the dissatisfactory of this technique where its performance is slower than bang-bang torque input function.

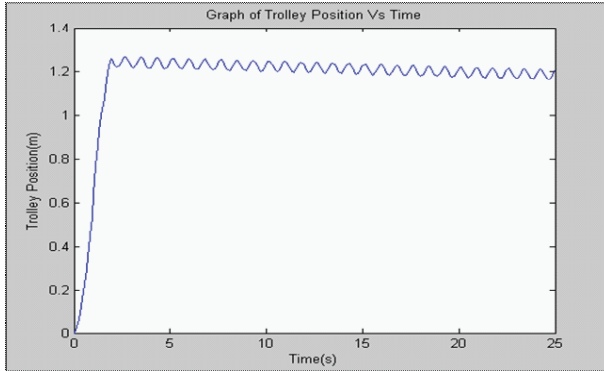

FIGURE 8

Trolley positioning by using bang-bang torque input function

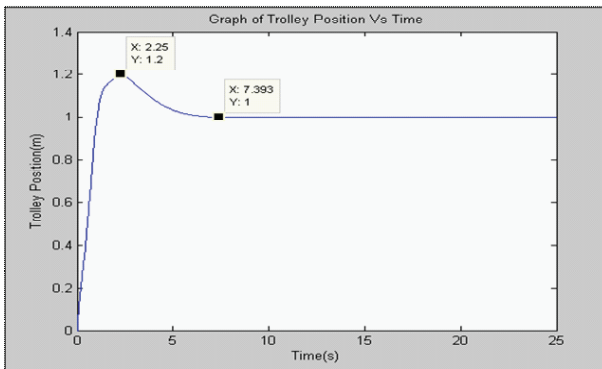

FIGURE 9

Trolley positioning by using dynamic feedback swing controller

The time response of the trolley position has been simplified in Table 2. Although the settling time and rise time of bang-bang torque input function is faster than dynamic feedback swing controller, in terms of vibrations, the performance of dynamic feedback swing controller is better than bang-bang input force.

TABLE 2  
Time Response of Trolley Positioning

Performance	Bang-Bang Torque	Dynamic Feedback
Input Function	Swing Controller	
Settling time (s)	2.00	7.39
Rise time (s)	1.27	2.25



## **5.0 CONCLUSIONS**

By using the developed model, the dynamic behaviors of the controller has been evaluated using MATLAB and SIMULINK. The performance of the controller are examined in terms of vibration reduction of sway angle and a stable positioning. Simulation results have shown that a dynamic feedback swing controller can be applied to control vibration. Satisfactory vibration reduction of a crane system has been achieved using the proposed technique.

## **6.0 ACKNOWLEDGEMENT**

This research is financially supported by CRIM, Universiti Teknikal Malaysia Melaka.

## **7.0 REFERENCES**

- A. Piazzzi, and A. Visioli. 2000. Minimum Time System Inversion-Based Motion Planning for Residual Vibration Reduction. *IEEE/ASME Trans. Mechatronics*, pp. 12-22.
- D.W. Frakes. 2001. Input-Shaped Control of Gantry Cranes: Simulation and Curriculum Developmen. *Proceedings of the Eighteenth ASME Biennial Conference on Mechanical Vibration and Noise*.
- G.A. Manson.1992.Time-optimal control of an overhead crane model. *Optimal Control Applications & Methods*, Vol. 3, No. 2, pp.115-120.
- H.M. Omar. 2003. Control of Gantry and Tower Cranes. Ph.D. Thesis. M.S. Virginia Tec. 12-25.
- J.K. Cho and Y.S. Park. 1995. Vibration reduction in flexible systems using a time-varying impulse sequence. *Robotica*, 13, pp. 305-313.
- M. Kenison. and W. Singhose. 1999. Input Shaper Design for Double-Pendulum Planar Gantry Cranes. *Control Applications*, pp. 539-544; 1999.
- M. N Sahinkaya. 2001. Input Shaping for vibration-free positioning of flexible systems. *Proceedings of Institution Mechanical Engineers*, Vol 215, pp. 467-481.
- Wahyudi and J. Jalani. 2005. Design and Implementation of Fuzzy Logic Controller for an Intelligent Gantry Crane System. *Proceedings of the 2nd International Conference on Mechatronics*, pp. 345-351.
- Wildi and Theodore. 2000. *Electrical Machines, Drives and Power Systems*. Fourth edition. Prentice-Hall Inc. 417-433; 2000.
- Y.S. Kim, H.S. Seo, and S.K. Sul. 2001. A New Anti-Sway Control Scheme for Trolley Crane System. *Proceedings of Industry Applications Conference*, Vol. 1, pp. 548-552.

