

**GENETIC, BIOCHEMICAL AND PHYSIOLOGICAL CHARACTERISTICS OF THE
RECOMBINANT STRAIN *LACTOBACILLUS* RL15, OBTAINED BY
INTERGENERIC HYBRIDIZATION BETWEEN
LACTOBACILLUS ACIDOPHILUS 2 AND *BIFIDOBACTERIUM BIFIDUM* L1**

*Rositsa DENKOVA¹, I. DOBREV¹, Zapriana DENKOVA², Velichka YANAKIEVA²,
Zoltan URSHEV¹, Maria YORDANOVA¹, Svetla ILIEVA¹

¹ Department „Biotechnology”, Faculty of Biology, Sofia University „St. Kliment Ohridski”, Sofia, Bulgaria,
rositsa_denkova@mail.bg

² Department „Organic chemistry and microbiology”, University of Food Technologies, Plovdiv, Bulgaria,
zdenkova@abv.bg

*Corresponding author

Received 10 December 2011, accepted 5 February 2012

Abstract: A successful intergeneric recombination by protoplast fusion between *Lactobacillus acidophilus* 2 and *Bifidobacterium bifidum* L1 is performed. The strain *Lactobacillus* RL15 with high reproductive capacity and moderate acidity, that doesn't cause sliming of milk is selected. Using modern molecular genetic methods it has been found that the hybrid inherits the genome of one of the parental strains. It is shown that in the united genome occur changes, which are expressed in the hybrid's phenotypic properties, enzyme profile and technological parameters.

Key words: intergeneric recombination, protoplast fusion, *Lactobacillus*, *Bifidobacterium*, ARDRA, AFLP

1. Introduction

Hybridization by protoplast fusion of cells belonging to the same or different types of microorganisms allows to unite in one genome characteristics of both the parental strains [1, 2, 3, 4, 5, 6]. Thus conditions for obtaining a heterogeneous population are created, and recombinants with new useful properties, such as increased proliferation, bacteriocin producing ability, higher lipase, amylase, β -galactosidase activity, with the ability to develop in a wide temperature range or other properties, might be selected.

According to Yeehn et al., 1996 [6] genetic recombination through protoplast fusion as a result of the union of the genomes of the parental cells allows not only to improve the features of the producers, but also to acquire new ones. The aim of the present study is to reveal the similarities and the differences in the genome, biochemical and technological

properties between the recombinant strain *Lactobacillus* RL15, obtained by intergeneric genetic recombination by protoplast fusion between *Lactobacillus acidophilus* 2 and *Bifidobacterium bifidum* L1, and each of the parental cultures.

2. Materials and methods

Determination of the biochemical profile

The system API 50 CHL (BioMerieux SA, France) is used for the identification of the species of the genus *Lactobacillus* based on their ability to utilize 49 carbon sources. Fresh 24-hour culture of the studied strain is centrifuged for 15 min at 5000xg. The obtained sludge, containing biomass, is washed twice with PBS-buffer and resuspended in medium API 50 CHL, an integral part of the used kit. The API strips are placed in the incubation boxes, the microtubules are inoculated with the prepared cell suspension and sealed with

sterile liquid paraffin. The results are reported on the 24th and the 48th hour of incubation at 37°C ± 1°C. Reporting is done, based on the colour change of each microtubule, compared to the colour of the control microtubule (microtubule 0). Positive results were recorded in the cases of color change to green or bright yellow. The obtained results are processed with apiweb ® identification software.

Profile of enzyme activity

The system API ZYM (BioMericux, France) is used for semi-quantitative determination of the enzyme profile of the studied strains. Fresh 24-hour culture of the studied strain is centrifuged for 15 min at 5000xg, the resulting sludge, containing biomass, is washed twice and resuspended in API suspension medium. The API ZYM strips are placed in the incubation boxes and the wells are inoculated with the prepared cell suspension. The samples are incubated for 4 hours at 37°C. Then one drop of reagent A and reagent B are added to each well. After 5 min staining is recorded as described in the color scheme in the manufacturer's instructions. Enzyme activity is determined by the color scale from 0 (no enzyme activity) to 5 (maximum enzyme activity).

Genetic methods

Isolation of total DNA is performed by the method of Delley et al., 1990.

ARDRA (Amplified Ribosomal DNA Restriction Analysis)

The method ARDRA involves PCR-amplification of the gene encoding 16S rRNA, using primers complementary to the conservative regions at both ends of the 16S rRNA gene, followed by restriction with restriction enzymes. The resulting profile is strictly specific for the particular tested species.

DNA of the studied strain is amplified using universal primers for the 16S rDNA gene - fD1 and rD1 (Weisburg WG, 1991). The amplification program includes: denaturation - 95°C for 3 min, 40 cycles - 93°C for 30 s, 48°C for 60 s, 72°C for 60 s, final elongation - 72°C for 5 min.

The resulting PCR product from the 16S rDNA amplification of the tested strain is treated with endonucleases: EcoRI, *AluI*, *HapII* and *TaqI* (Boehringer Mannheim GmbH, Germany). The resulting restriction products are visualized on a 2% agarose gel.

AFLP (Amplified Fragment Length Polymorphism)

AFLP is developed and performed for the two pairs of endonucleases: *BamHI/PstI* and *HindIII/MboI*.

AFLP is a genomic typing technique based on selective amplification of a set of fragments after restriction of genomic DNA. The method consists of 3 steps:

1. DNA restriction and ligation of adapters (linkers) to the corresponding restriction sites.
2. Selective amplification of a set of fragments.
3. Amplified fragment analysis using polyacrylamide electrophoresis.

PCR amplification is achieved by using the common sequence of the restriction site and the adapter, ligated to it, as a target site for the primers. Selective amplification is achieved using primers that have one or more selective nucleotides in their 3' end. For detection of the PCR product one of the primers needs to be fluorescently (or radioactively) labeled. After amplification fragments of about 50-100 are obtained, for which there is no preliminary information about their sequence. The fragments are then separated using polyacrylamide gels.

Periodic cultivation

Bioreactor and cultivation conditions

The laboratory bioreactor is a cylinder with a geometric volume of 2 dm³ and working

volume - 1,5 dm³.

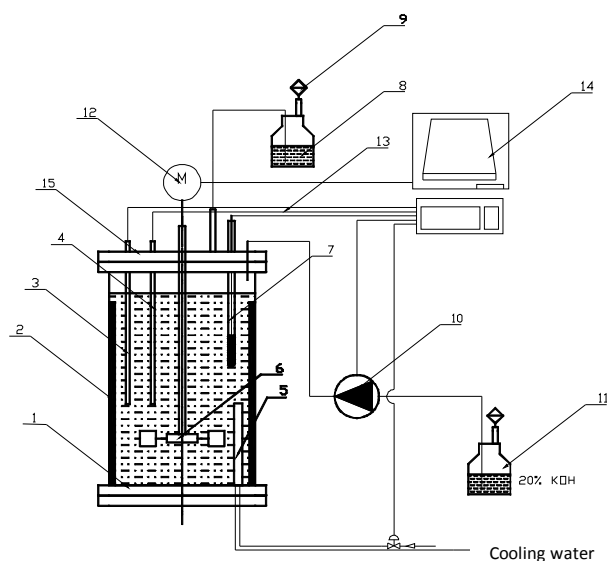

Fig. 1. Scheme of the laboratory bioreactor

1 - vessel with geometric volume of 2 dm³; 2-four repulse devices ; 3–thermo-strength Pt100 ; 4–heater ; 5–heat exchanger for cold water ; 6–turbine stirrer ; 7–pH electrode ; 8–exit for CO₂; 9–filter ; 10–peristaltic pump for pH correction ; 11– reagent for pH correction – 20% KOH; 12–motor ; 13–control links ; 14–control device "Applikon"

Periodic cultivation processes are carried out using two media: skimmed cow's milk or pasteurized goat's milk without pH adjustment. Skimmed milk medium is sterilized at 121°C for 20 min. After cooling to 37°C the prepared media in the bioreactor is inoculated with 5% (v/v) inoculum from a fresh 24-hour culture of the studied strain, cultivated in skimmed cow's milk or pasteurized goat's milk. The process of cultivation is carried out at 37°C, stirring speed of 100 rpm, without air supply. The duration of the cultivation is different (up to the 7th hour, up to the 24th hour), and samples of the cultural medium are periodically taken in order to determine the number of viable cells of the strain (cfu/cm³) and the titratable acidity. The bioreactor is equipped with sensors for pH and Eh (oxidation reduction potential), so at each sampling these parameters are recorded as well.

Along with the cultivation conducted in dynamic conditions (in a bioreactor), cultivation at static conditions (in a thermostat) was conducted as well.

3. Results and discussion

A successful intergeneric hybridization was performed between the cells of *Lactobacillus acidophilus* 2 and *Bifidobacterium bifidum* L1. From the regeneration medium recombinants resistant to the antibiotics streptomycin and neomycin sulfate were isolated.

Recombinants, which are characterized by moderate titratable acidity, relatively short coagulation time of milk, without slime formation, and no change in morphology, were selected among them.

The proliferation ability of the selected recombinants and the parental cultures in microaerophilic and anaerobic static

conditions was determined. The results show that during the time from the 6th to the 12th hour all the recombinants achieve high concentration of viable cells - 2 log units higher in comparison with the concentration of viable cells in anaerobic conditions. In that capacity, they resemble the parental strain *L.acidophilus* 2. The best growth in obligate (anaerobic) conditions show two recombinants: *Lactobacillus* RD6 ($2,0 \cdot 10^{11}$ cfu/cm³) and *Lactobacillus* RL15 ($1,0 \cdot 10^{10}$ cfu/cm³), which resemble the other parental strain *B.bifidum* L1.

Biochemical profile of the recombinant *Lactobacillus* RL15, obtained by hybridization between *L. Acidophilus* 2 and *B.bifidum* L1.

Genetic recombination through protoplast fusion results in uniting in a hybrid cell the genetic structures of the two parental cells. The changes that occur in the integration are reflected in the phenotype of the newly obtained recombinants. Along with the physiological peculiarities, changes in their biochemical properties are observed as well.

Using the API 50 CHL (BioMerieux SA, France) the biochemical profile of the recombinant strain and the parental strains is defined. The degree of similarity between the hybrid and the parental strains, according to the ability of each strain to utilize 49 carbohydrate sources, is determined.

Table 1
Biochemical profile of the hybrid *Lactobacillus* RL15 and the parental cultures *L.acidophilus* 2 and *B.bifidum* L1

#	Carbohydrates	<i>L.acidophilus</i> 2	<i>B. bifidum</i> L1	<i>Lactobacillus</i> RL15
1	Glycerol	-	-	-
2	Erythriol	-	-	-
3	D-arabinose	-	-	-
4	L-arabinose	-	-	-
5	Ribose	+ (80-85%)	+ (80-100 %)	-
6	D-xylose	-	-	-
7	L-xylose	-	-	-
8	Adonitol	-	-	-
9	β-metil-D-xyloside	-	-	-
10	Galactose	+ (90-100%)	-	-
11	D-glucose	+ (90-100%)	+ (80-100 %)	+ (50-60%)
12	D-fructose	+ (90-100%)	-	-
13	D-mannose	+ (90-100%)	+ (80-100 %)	-
14	L-sorbose	+ (90-100%)	-	-
15	Rhamnose	+ (50-60%)	+ (80-100 %)	-
16	Dulcitol	+ (90-100%)	-	-
17	Inositol	-	-	-
18	Manitol	+ (90-100%)	+ (80-100 %)	-
19	Sorbitol	+ (80-85%)	+ (80-100 %)	-
20	α-methyl-D-mannoside	-	-	-
21	α-methyl-D-glucoside	+ (80-85%)	-	-
22	N-acetyl-glucosamine	+ (90-100%)	-	-
23	Amigdaline	+ (80-85%)	-	-
24	Arbutin	+ (80-85%)	-	-
25	Esculin	-	-	-
26	Salicin	+ (90-100%)	+ (80-100 %)	-
27	Cellobiose	-	+ (80-100 %)	-
28	Maltose	-	-	-
29	Lactose	+ (90-100%)	+ (80-100 %)	+ (90-100%)
30	Melibiose	-	-	-
31	Saccharose	-	+ (80-100 %)	-
32	Trehalose	+ (90-100%)	-	-
33	Inulin	-	-	-
34	Melezitose	-	-	-
35	D-raffinose	-	-	-
36	Amidon	-	-	-
37	Glycogen	-	-	-
38	Xylitol	-	-	-
39	β-gentiobiose	-	-	-
40	D-turanose	-	-	-
41	D-lyxose	-	-	-

42	D-tagarose	+ (50-60%)	-	-
43	D-fucose	-	-	-
44	L-fucose	-	-	-
45	D-arabitol	-	-	-
46	L-arabitol	-	-	-
47	Gluconate	+ (50-60%)	-	+ (60-70%)
48	2-keto-gluconate	-	-	-
49	5-keto-gluconate	-	-	-

The recombinant strain *Lactobacillus* RL15 has suffered profound changes in the genome that affect some regulatory mechanisms. Unlike the parental cultures he has the ability to assimilate only glucose and lactose (Table 1).

Examination of the enzyme profile

The enzyme profile is important in determining the technological characteristics of lactobacilli and their applicability as starter cultures for production of various dairy, meat and bakery products.

Therefore, the enzyme activity of the strains *L. acidophilus* 2, *B. bifidum* L1 and

Lactobacillus RL15 is determined using API ZYM (BioMerieux, France). The results of these studies are shown in Table 2.

The hybrid *Lactobacillus* RL15 has a weak alkaline phosphatase, C8 lipase, trypsin and chymotrypsin, and α -glucoseaminidase activity. The similarity between its enzyme activities and the enzyme activities of the parental strain *B. bifidum* L1 is logical. The hybrid's β -galactosidase and leucine-aminopeptidase enzyme activity, moderate acid phosphatase, naphthol-AS-BL-phosphohydrolase, cysteine-aminopeptidase activity resemble the profile of the parental strain *L. acidophilus* 2.

Table 2
Enzymatic profile of the strains *B. bifidum* L1, *Lactobacillus* RL15 and *L. acidophilus* 2

Enzyme	Activity* <i>B. bifidum</i> L1	Activity* <i>Lactobacillus</i> RL15	Activity* <i>L. acidophilus</i> 2
1 Control	-	-	-
2 Alkaline phosphatase	-	0.5	-
3 Lipase C ₄	1	0.5	0.5
4 Lipase C ₈	1	0.5	-
5 Lipase C ₁₄	0.5	1	0.5
6 Leucine-aminopeptidase	5	4	4
7 Valine-aminopeptidase	5	3.5	3
8 Cysteine-aminopeptidase	1	3	3.5
9 Trypsin	-	0.5	-
10 Chymotrypsin	0.5	0.5	-
11 Acid phosphatase	3	1.5	1
12 Naphthol-AS-BL-phosphohydrolase	3	1	1
13 α – galactosidase	3.5	-	-
14 β -galactosidase	5	5	5
15 B-gluconidase	-	-	-
16 α – glucosidase	3.5	-	-
17 β -glucosidase	4	-	-
18 α -glucoseaminidase	2	0.5	-
19 α -manosidase	-	-	-
20 α -fucosidase	0.5	-	-

The ability of the strains to synthesize enzymes is essential for the uptake of substrates and the formed metabolites are

involved in the formation of the taste-aromatic complex of dairy and meat foods.

ARDRA

The hybrid *Lactobacillus* RL15, obtained by protoplast fusion between *L. acidophilus* 2 and *B.bifidum* L1, has the same restriction profile of the gene encoding 16S rRNA with the restriction enzyme *TaqI* as the acidophilic parent (Fig.1). Most likely the hybrid *Lactobacillus* RL15 has inherited the gene

for 16S rRNA from the parental culture *L. acidophilus* 2.

The parental strains *L. acidophilus* 2 and *B.bifidum* L1, as well as their recombinant have a restriction site for the enzyme *EcoRI*, but the restriction profile of the hybrid shows greater similarity with the restriction profile of the parental culture *L.acidophilus* 2 (Fig. 1b).

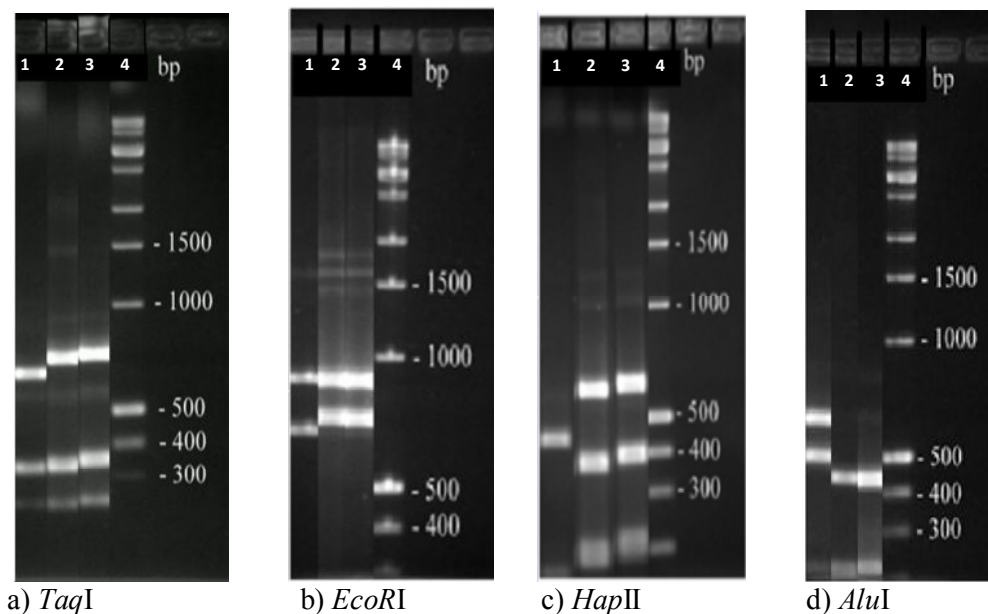

Fig. 1. Restriction profile: 1 *B. bifidum* L1; 2 - *L. acidophilus* 2; 3 - *Lactobacillus* RL15; 4 - KBASE PLUS marker (USB)

The dependencies between the restriction profiles of the recombinant strain and the parental cultures, obtained with the restriction enzymes *HapII* and *AluI*, are similar to the dependencies between the profiles, obtained with *EcoRI* and *TaqI* (Fig. 1c and Fig. 1d).

The applied molecular genetic method shows that the hybrid has inherited the 16S rRNA gene from one of its parents - *L.acidophilus* 2. These results show the predominant presence of one of the parental strains in the genetic recombination that occurred in the process of merging of the protoplasmic cultures. Therefore, the next step in the

molecular-genetic typing is the conduction of AFLP - analysis of genomic DNA.

AFLP

AFLP – analysis of the hybrid *Lactobacillus* RL15 and the two parental strains *L.acidophilus* 2 and *B.bifidum* L1 with two pairs of endonucleases - *BamHI/PstI* and *HindIII/MboI* - was conducted. The results of these studies are shown on Fig. 1 and Fig. 2.

The obtained after computing dendrograms confirmed the results of the ARDRA - analysis. This recombinant resembles to a greater degree the parental strain *L.acidophilus* 2 (Fig. 2b and Fig. 3b). Changes that occurred in the genome of

the hybrid, although low (15%), find expression in its phenotypic features – its

biochemical and physiological properties.

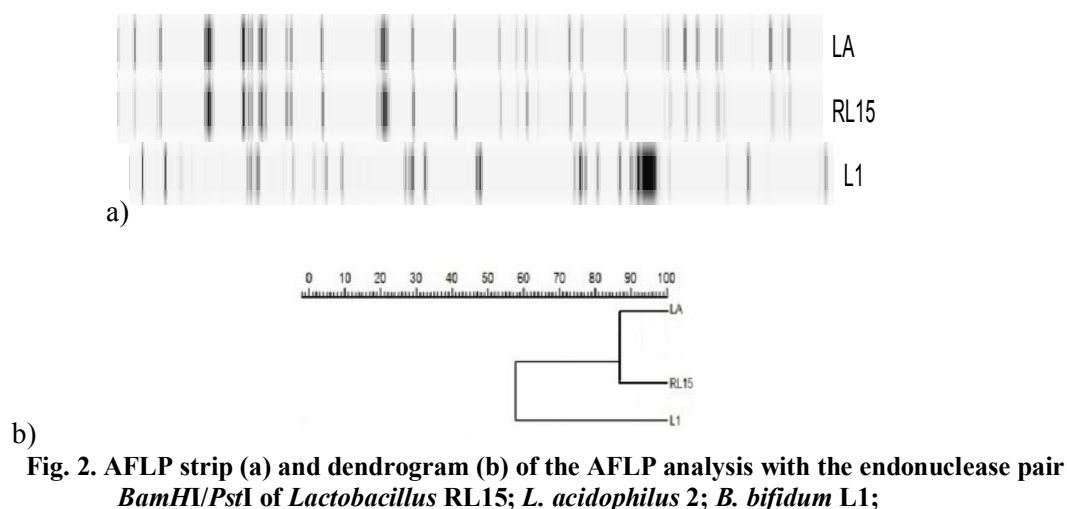

Fig. 2. AFLP strip (a) and dendrogram (b) of the AFLP analysis with the endonuclease pair *BamHI/PstI* of *Lactobacillus* RL15; *L. acidophilus* 2; *B. bifidum* L1;

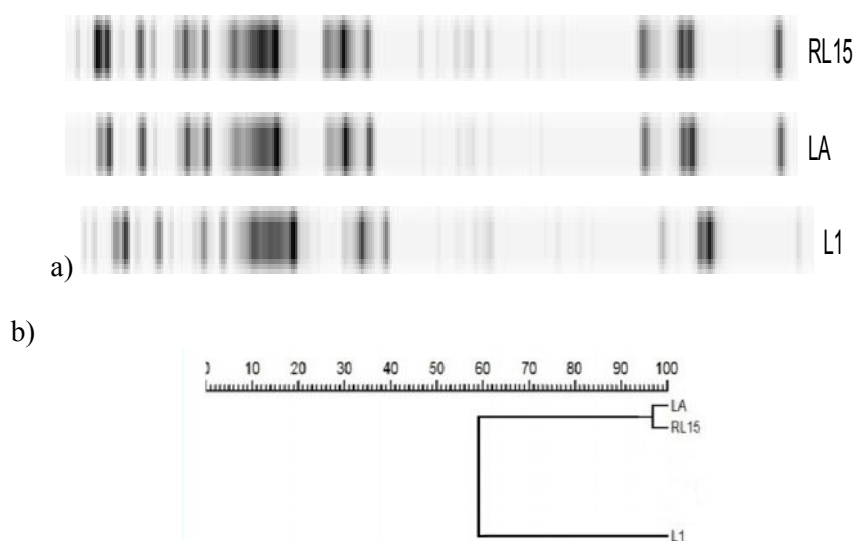

Fig. 3. AFLP strip (a) and dendrogram (b) of the AFLP analysis with the endonuclease pair *HindIII/MboI* of *Lactobacillus* RL15; *L. acidophilus* 2; *B. bifidum* L1

Dynamics of proliferation of the parental strains and the recombinant under static conditions and in a bioreactor with continuous stirring

The main parameters of the fermentation process – coagulation time, titratable acidity of the medium, proliferation ability, oxidation-reduction potential (Eh) and pH - during the cultivation of the parental strains and the hybrid in a bioreactor with continuous stirring and at static conditions were tracked.

In the cultivation of *L.acidophilus* 2 at static conditions at $37\pm 1^{\circ}\text{C}$ for 12 hours and for 24 hours the concentration of viable cells reached 8.10^{10}cfu/cm^3 and 5.10^{11}cfu/cm^3 , respectively. The titratable acidity starts to grow with the entry of the culture in the exponential growth phase and continues up to the 24th hour from the beginning of the process, reaching 180°T (Fig. 4a).

In the bioreactor better conditions for the development of the strains are created. At the 6th hour the microbial content is

$8 \cdot 10^{10}$ cfu/cm³. Lactobacilli need a limited amount of oxygen because they are microaerophiles. In the studied strain long

lag-phase (about 4h) is observed, then the exponential growth phase starts.

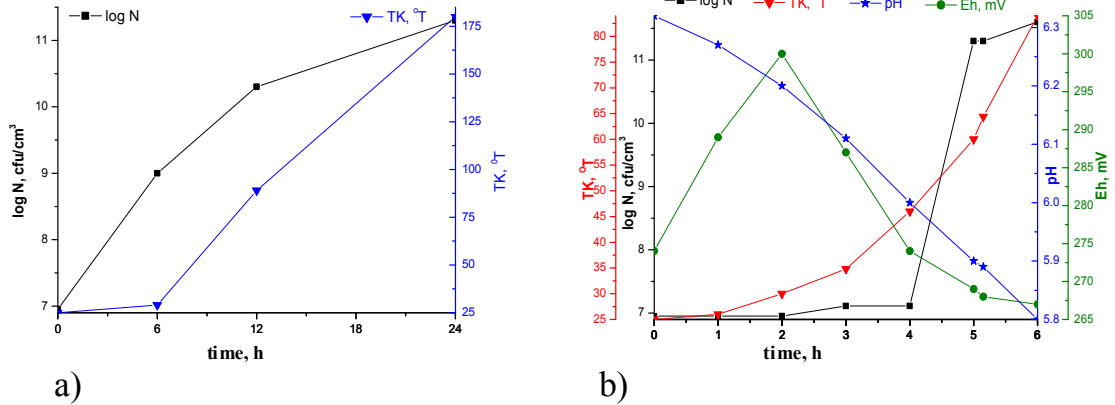

Fig. 4. Dynamics of proliferation and accumulation of organic acids in cultivation of *L.acidophilus* 2 under static conditions (a) and in a bioreactor with continuous stirring (b).

The curve, reflecting the titratable acidity is similar to the growth curve. It continues to increase after the culture enters the stationary phase of growth and reaches a value of 85°T. The accumulated acid is almost two and a half times less than that under static conditions (Fig. 4b).

Up to 2nd hour after the start of the fermentation process oxidation increases, reaching + 300 mV, then changes its direction towards reduction with the culture entering the exponential growth phase. At the end of logarithmic growth phase the value of the redox potential is about +265 mV.

The cells of bifidobacteria significantly differ from the acidophilic strains in their development. Under static conditions *B.bifidum* L1 has a short lag-phase and exponential growth up to 12th hour from the start of the fermentation process. At the end of the process high concentration of viable cells (10^{15} cfu/cm³) and titratable acidity (65°T (Fig. 5a)) are achieved.

The same concentration of active cells accumulates in the medium for a shorter time (7h) in the cultivation of *B.bifidum* L1 in a bioreactor with continuous stirring (Fig. 5b).

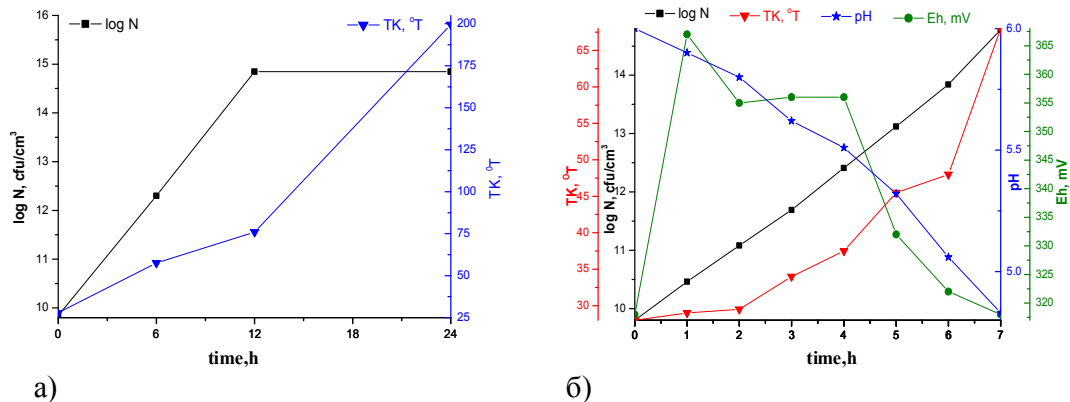

Fig. 5. Dynamics of proliferation and accumulation of organic acids in *B.bifidum* L1 under static conditions (a) and at periodic cultivation in a bioreactor with continuous stirring (b).

For the same time the titratable acidity of the medium increased to 65°T. The results confirm the studies of Schiraldi et al., 2003, that under microaerophilic conditions biomass is accumulated, and under anaerobic conditions primarily lactic acid is accumulated.

During the phase of adaptation to the conditions of the medium the oxidative potential increases up to +370 mV, but with the entering of the culture in the exponential phase of growth it starts to decline and keeps this tendency until the end of the process when it reaches +320 mV, probably due to the reducing capacity of the cells.

Distinct phases of growth are detected in *Lactobacillus* RL15 under static growth conditions.

A concentration of $2,0 \cdot 10^{11}$ cfu/cm³ viable cells is reached for 12 hours under static conditions at 37°C (Fig. 9a). During this

time the titratable acidity reaches 160°T. With the further development of the culture up to the 24th hour the concentration of viable cells in the medium reaches $1,0 \cdot 10^{12}$ cfu/cm³, without any significant change in the values of the titratable acidity (Fig. 6a).

A concentrate of $1,0 \cdot 10^{10}$ cfu/cm³ with titratable acidity 90°T is obtained by periodic cultivation of *Lactobacillus* RL15 in a bioreactor with continuous stirring for 5h (Fig. 9b).

In this strain during the lag-phase the redox potential decreases and in the phase of active multiplication during the exponential phase continues to decrease until the passage of the microbial cells in the stationary phase of growth, then it gradually increases. This is a result of the changes in the ratio of oxidized and reduced forms in the medium (Fig. 6b).

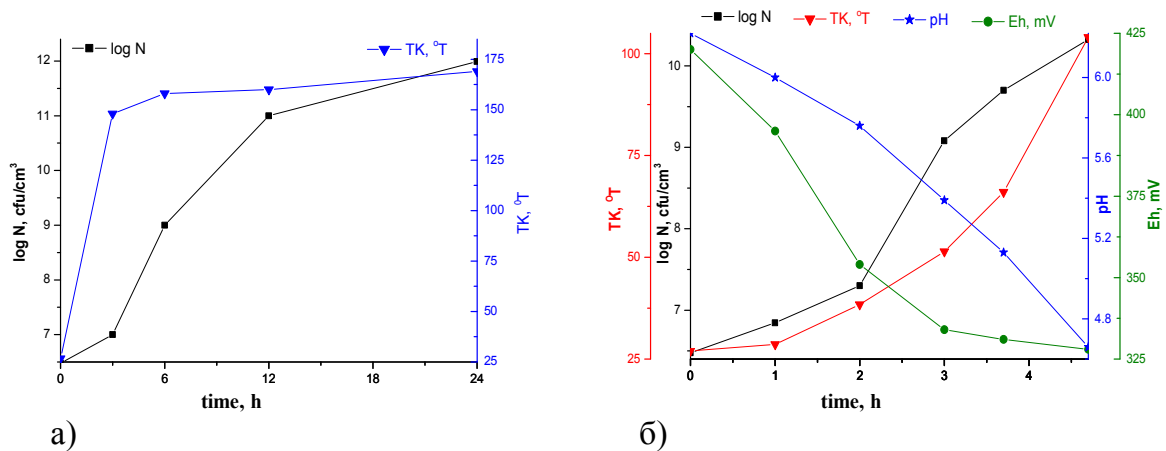

Fig. 6. Dynamics of proliferation and accumulation of organic acids in cultivation of *Lactobacillus* RL15 under static conditions (a) and in a laboratory bioreactor with continuous stirring (b).

Such concentrates with beneficial microorganisms to human health are applied as liquid probiotic drinks.

4. Conclusion

1. Through molecular genetic methods (ARDRA and AFLP) the genomic similarities and differences between the hybrid and the parental cultures are revealed:

1.1. The recombinant strain *Lactobacillus* RL15 derived from the hybridization of *L.acidophilus* 2 and *B.bifidum* L1 inherits

the gene for the 16S rRNA from the parent culture *L.acidophilus* 2.

1.2. It is shown that the recombinant strain retained the genome of one of the parents to a great extent, and in its genome changes occur as a result of the conducted protoplast fusion, giving individual characteristics to the hybrid.

1.3. It is revealed that in the united genome occur changes in the regulatory

mechanisms, which are expressed by the loss of the ability of the recombinant strain to utilize carbon sources.

2. High concentration of viable cells (10^{12} - 10^{15} cfu/cm³) in the static and the dynamic process of cultivation is obtained.

3. The patterns of the change of the oxidation-reduction potential of the media in the cultivation of the recombinant strain and the parental cultures are revealed. In lactobacilli the redox potential increases during the lag-phase, decreases during the exponential phase until the cultures enter

the stationary phase of growth, with subsequent retention. In *B.bifidum* L1 it increases during the lag-phase, continues slowly to grow during the exponential phase and gradually decreases during the stationary phase. In the recombinant derived from the intergeneric hybridization between *L.acidophilus* 2 and *B.bifidum* L1, the oxidation-reduction potential decreases during the lag-phase and the logarithmic growth phase, slightly increases during the transition of the culture in the stationary phase of growth.

5. References:

[1] GUPTA R. K. and V. K. BATISH, (1992a) "Genetic evidence for plasmid-encoded lactococcin production in *L. lactis* subsp. *lactis* 484". *Curr. Microbiol.*, 24: 231-238.

[2] GUPTA R. K. and V. K. BATISH, (1992b), "Protoplast-induced curing of bacteriocin plasmid in *L. lactis* subsp. *lactis* 848". *Y. Appl. Bacteriol.*, 73: 337-341.

[3] GUPTA R. K. and V. K. BATISH, (1992c), "Lytic response of *L. lactis* subsp. *lactis* 484 of muralytic enzymes". *Enzyme Microbiol. Technol.*, 14: 156-160.

[4] HAYES F., E. CAPLICE, A. MCSWENY AND DALY., (1990), "pAM β 1-associated immobilization of proteinase plasmids from *L. lactis* subsp. *lactis* UC317 and *L. lactis* subsp. *cremoris* UC205". *Environ. Microbiol.*, 56 (1): 195-201.

[5] KIM. H. AND M. CHASSY, (1994), Study in the plasmid gene transformation of *Lactobacillus casei* – 36 (21) 212-216.

[6] YEEHN Y., YOUNG BAE IO AND OH CHANG, (1996), Protoplast fusion between *L.casei* and *L.acidophilus* "Rwou, Biotechnology Letters, v. 8 (7) p 805-808.