

NUMERICAL ANALYSIS OF THE STRESS STATE IN A PLATING FLOOR FOR A 8000 TDW CHEMICAL TANKER

Năstasă Alina - Mihaela

"Dunarea de Jos" University of Galati,
Faculty of Naval Architecture, Galati, Domneasca
Street, No. 47, 800008, Romania,
E-mail: alina.nastasa99@yahoo.com

Anișoara - Gabriela Cristea

"Dunarea de Jos" University of Galati,
Faculty of Naval Architecture, Galati, Domneasca
Street, No. 47, 800008, Romania,
E-mail: anisoara.cristea@ugal.ro

ABSTRACT

The analysis has the purpose to determine the stresses that will occur in the structure under unfavorable conditions. Depending on the results, intervention will be made upon the structure to ensure the resistance of the vessel, optimizing of the elements of the framing system in the areas where the maximum allowable stresses are exceeded.

The analysis will be performed on a cargo tank, for three static stress cases, the vessel being placed on still water, on sagging and hogging.

Keywords: finite element method, hydrostatic water pressure, , mechanical structural, stress calculation.

1. GENERATING AND ANALYSIS OF THE MODEL

The study was carried out in FEMAP/NX Nastran. FEMAP/NX Nastran is a simulation software program that helps to create finite element analysis models of complex systems and solution results. FEMAP/NX Nastran can model components, assemblies or systems and determine the behavioral response for a given operating environment.

The studied FEM model was extended along the length of a cargo tank in the central area of the vessel, with vessel - wave balancing parameters, calculated using the equivalent beam model, these parameters are suitable for the resistant analysis of the vessel hull in the areas where the global stresses are dominant, respectively for the central areas of the cargo compartments.

The hull of commercial vessels has trapezoidal shapes in the central area, thus, for the analyzed model, it is sufficient to know the shape of the cross sections at the master torque.

The structure was modeled in FEMAP with the dimensions shown in **Table 1.1**, based on the dimensions of the structural elements that make up the master sections, a section that was made using the POSEIDON ND v.21.4 program package belonging to the DNV classification company.

Table 1.1 The main characteristics of the simplified structure

$L_{pp} = 18,16$ [m]	$D_w = 8000$ tdw	$h_{wmax} = 6,1$ [m]
$B = 18,5$ [m]	$L_{cargo} = 29,484$ m	$E = 2,1E+5$ [N/mm ²]
$D = 10$ [m]	$a_L = 0,702$ [m]	$\nu = 0,3$
$T = 7,4$ [m]	$a_F = 2,106$ [m]	$\rho_{steel} = 7800$ [kg/m ³]

where:

L_{pp} - length between perpendiculars;

B - breadth;

D - depth;

T - scantling draught;

D_w - displacement;

h_w - wave height;

E - Young's modulus;

ν - Poisson's ratio;

a_L - intercostal distance;

a_F - distance between two floors.

The model is made only on a cargo tank, between frame 77 and frame 119 (**Fig.1.1**), in a single board. The structure is simplified by eliminating brackets and stiffening ribs, but also by simplifying the simple framing system, from bulb profiles (HP) to flat band profiles (FB).

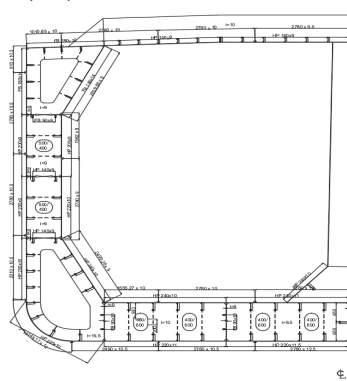

Fig. 1.1 Cross-section area at the amidships section

2. THE FEATURES OF THE MATERIAL

The material used for this structural analysis is high strength steel, for which the yield stress is $\sigma_c = 235$ MPa, the longitudinal modulus of elasticity (Young's modulus) is $E = 210$ GPa, Poisson's ratio is $\nu = 0.3$ and density of the steel material $= 7800$ kg/m³.

3. GEOMETRY AND MESH

To highlight voltage concentrators in all structural elements, it is necessary to use the membrane and plating elements implemented in the FEM program.

The plate type elements (PLATE - Mindlin) implemented in the FEM program were used in the FEM model.

Most of the elements are quadrilaterals, but if they cannot be used, triangular elements are used.

The variation of the shapes and sizes of the elements in the FEM model occurs due to the different sizes of the longitudinal profiles and their positions.

Following the making of the 3D-CAD model, 16524 points, 28136 curves and 11856 surfaces resulted (**Fig. 1.2a** and **Fig. 1.2b**).

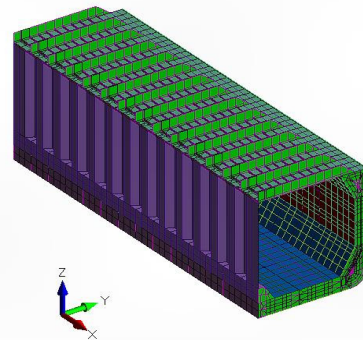

Fig.1.2a 3D - CAD model of the cargo tank

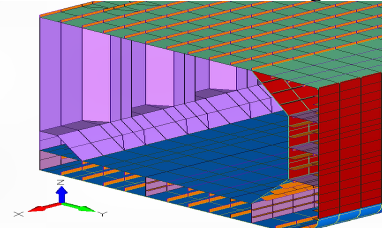

Fig.1.2b 3D - CAD model detail

Also, following the making of the 3D-FEM model, 216644 nodes and 223133 elements resulted (**Fig. 1.3a** and **Fig. 1.3b**).

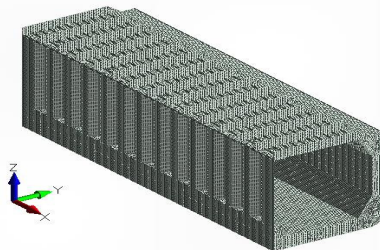

Fig.1.3a 3D - FEM model of the cargo tank

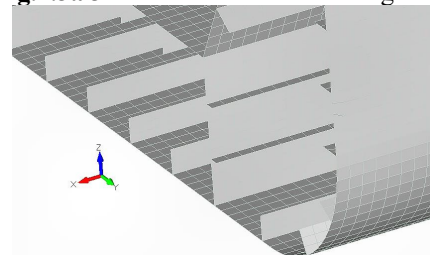

Fig.1.3b 3D - FEM model detail

4. EDGE CONDITIONS

As the loads of the model are made of quasi-static equivalent waves or still water, the stresses of the model are only vertical symmetrical in relation to the diametrical plane (DP) of the hull.

The edge conditions applied on the FEM model have the role of simulate the existence of real structure of the vessel in the aft, in the fore and in the opposite board of the shaped warehouse.

These edge conditions used for the study of the model are shown in **Table 1.2**.

Table 1.2 Boundary conditions for the 3D - FEM model

Boundary condition	Blocked degrees of freedom					
	T _x	T _y	T _z	R _x	R _y	R _z
Symmetry in the diametral plane PD	-	x	-	x	-	x
Stern master node NDpp	x	x	x	x	-	x
Stern master node NDpv	-	x	x	x	-	x

There is the condition of symmetry applied on all nodes in the area where the symmetrical hatch is missing from the board opposite the model, the transverse movement and rotation being blocked along the longitudinal axis, the edge condition at the aft of the model allows only rotation along the transverse axis, and the edge condition at the bow of the model allows only longitudinal movement and rotation along the transverse axis (**Fig. 1.4**).

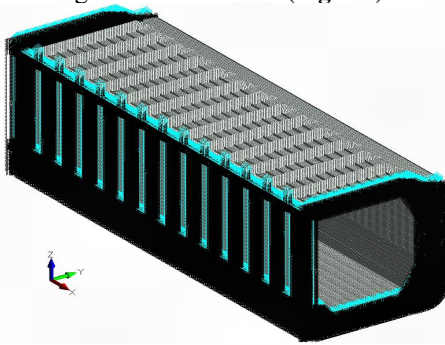

Fig. 1.4 Boundary conditions for the 3D - FEM model

5. LOADS APPLIED UPON THE MODEL

A. The case of static placement on still water

The FEM model is subjected to the following types of loads:

- Gravitational load given by the net weight of the structural elements of the vessel: $g = 9.81 \text{ m/s}^2$, $\rho = 7.8 \text{ t/m}^3$ and other components on board of the vessel in the area of the modeled cargo tank.

- The load given by the cargo is idealized on the double bottom shell, double board, longitudinal and transversal walls, as hydrostatic pressure in the cargo ($\rho = 0.9 \text{ t/m}^3$) [N/mm²], for a reference quota HHC (D=9000 mm).

The hydrostatic pressure is given by relation (1) where:

$$p = \rho g z \text{ [kN/m}^2\text{]} \quad (1)$$

where:

ρ – density of transported goods [t/m³];

g – gravitational acceleration [m/s²];

z – vertical distance to the highest point the goods reach inside the warehouse [m].

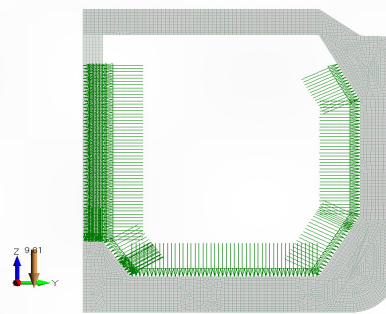

Fig. 1.5 Hydrostatic cargo pressure distribution ($\rho_{\text{cargo}} = 0.93 \text{ t/m}^3$)

□ The load from still water::

The load given by the sea water in which the hull of the vessel is immersed, idealized on the outer shell, as the hydrostatic pressure in the water ($\rho = 1,025 \text{ t/m}^3$), for a full load draught of $T = 7400 \text{ mm}$ (**Fig. 1.6**).

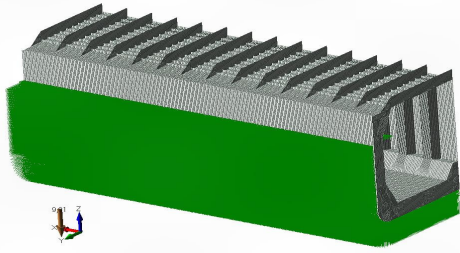

Fig. 1.6 Hydrostatic pressure generated by the still water ($\rho_{\text{water}} = 1,025 \text{ t/m}^3$)

B. The case of static placement on the wave

In the case of static vessel placement on the wave, the 3D-FEM model shall be subjected to the following types of loads:

- gravitational loading (same as in the case of placement on still water);
- the load given by the goods (the same as in the case of placement on still water);
- the load in the equivalent quasi-static meeting wave, with Smith correction, with the equivalent hydrostatic pressure $[\text{N/mm}^2]$, with the elongation relative to the basic plane of the vessel from the relation (2), taking into account the balancing parameters, calculated on the basis equivalent beam model, depending on the wave height h_w .

$$\begin{aligned} \xi_w(x) &= d_{pp} + (d_{pn} - d_{pp}) \frac{x}{L} \pm \frac{h_w}{2} \cdot \cos\left(\frac{2\pi x}{L}\right) \\ x \in [0, L], \text{ respectiv } x \in [x_{\text{inpp}}, x_{\text{inpn}}] \\ p_w(x) &= \rho \cdot g \cdot \xi_w(x), \rho = 1,025 \text{ t/m}^3 \\ h_w &= 1,25 \sqrt{\lambda} \end{aligned} \quad (2)$$

Where λ , the length of the wave, is considered equal to L_{vessel} , the length of the vessel, to consider the most unfavorable case.

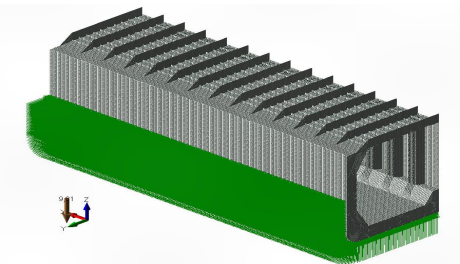

Fig. 1.7 Hydrostatic loading for the case of the ship on the

Following the calculation, the height of the wave used for the analysis on the sagging and hogging will be 6.1 meters (Fig. 1.7 and Fig. 1.8).

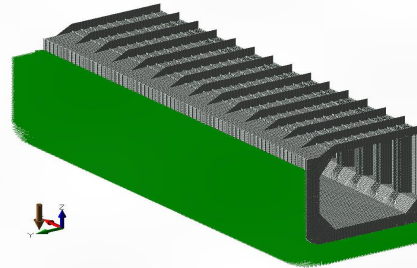

Fig. 1.8 Hydrostatic loading for the case of the ship on the wave crest

6. RESULTS OBTAINED FOLLOWING FEM ANALYSIS

Following FEM analysis, the maximum allowable stresses that appear on the structure will be checked.

The stresses will be compared with the maximum values accepted by the IMO, by the Common Structural Rules Convention, for vessels with $L \geq 150 \text{ m}$ and for vessels with $L < 150 \text{ m}$ will be compared with the values imposed by the used classification company.

For the studied vessel the rules of the classification company DNV (Table 1.3) will be used.

Table 1.3 Permissible coarse mesh yield utilisation $\lambda_{\text{yperm}}^{[5]}$

Structural member	Acceptance criteria	Load components ²⁾	λ_{yperm}
Plating of all longitudinal hull girder structural members, primary supporting structural members and bulkheads.	AC-I	S	0,8 ³⁾
	AC-II	S + D	1,0
	AC-III ⁴⁾	A, T	1,00
Dummy rod of corrugated bulkhead. Face plate of primary supporting members modelled using shell or rod elements.	AC-I	S	0,72 ⁴⁾
	AC-II	S + D	0,90
	AC-III ⁴⁾	A, T	0,90

1) For members of the collision bulkhead, AC-I shall be used.
 2) See Ch.1 Sec.2 (4.2).
 3) $\lambda_{\text{yperm}} = 0,85$ when hull girder permissible loads for harbour operations or special operations are applied.
 4) $\lambda_{\text{yperm}} = 0,77$ when hull girder permissible loads for harbour operations or special operations are applied.

The allowable stresses for the plates and profiles used in the structure will be calculated by multiplying the flow limit of the material to $\lambda_{\text{yperm}} = 0.8$.

Following the calculations, the medium stresses on an element for steel with flow limit 235 N/mm² should not exceed the value of 188 N/mm².

A. The case of static placement on still water

For the interpretation of the analyses, the maximum stresses in the structure and the medium stresses on the element will be taken into account (Table 1.4, Fig. 1.9 and Fig. 1.10).

Table 1.4 The stresses of plating floor on still water

Von Mises maximum stress	84,681 [N/mm ²]
Von Mises medium stress	42,341 [N/mm ²]
Von Mises minimum stress	0,0002382 [N/mm ²]

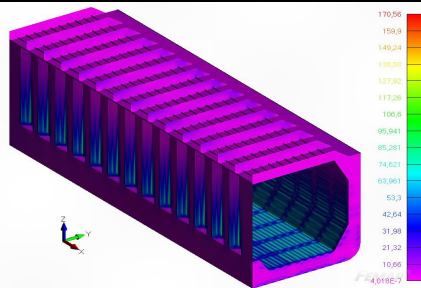

Fig. 1.9 Analysis of the cargo tank on still water, maximum stresses

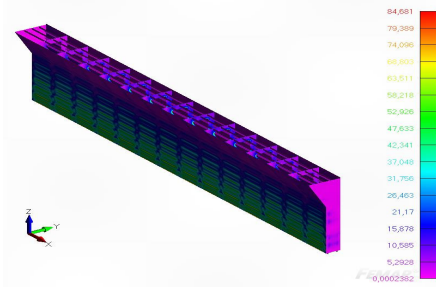

Fig. 1.10 Analysis of the plating floor on still water

B. The case of static placement on the wave

B1. The case of static placement on hogging

For the interpretation of the analyses, the maximum stresses in the structure and the medium stresses on the element will be taken into account (Table 1.5, Fig. 1.11 and Fig. 1.12).

Table 1.5 Stresses of the plating floor on hogging

Von Mises maximum stress	97,56 [N/mm ²]
Von Mises medium stress	48,78 [N/mm ²]
Von Mises minimum stress	0,0000953 [N/mm ²]

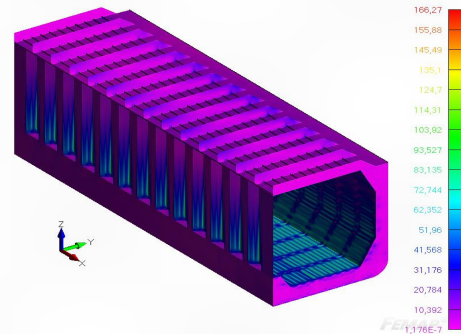

Fig. 1.11 Analysis of the cargo tank in the case of placement on hogging, maximum stresses

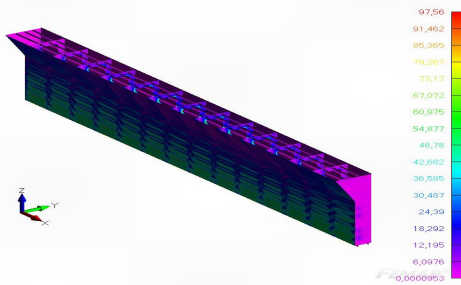

Fig. 1.12 Analysis of the plating floor on hogging

Fig. 1.13 Analysis of the cargo tank in the case of placement on sagging, maximum stresses

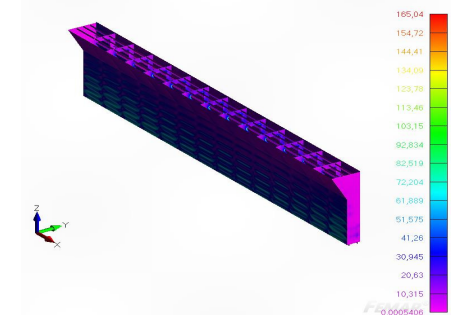

Fig. 1.14 Analysis of the plating floor on sagging

B2. The case of static placement of the vessel on the sagging

For the interpretation of the analyses, the maximum stresses in the structure and the medium stresses on the element will be taken into account (Table 1.6, Fig. 1.13 and Fig. 1.14).

Table 1.6 Stresses of the plating floor on sagging

Von Mises maximum stress	165,04 [N/mm ²]
Von Mises medium stress	82,519 [N/mm ²]
Von Mises minimum stress	0,0005406 [N/mm ²]

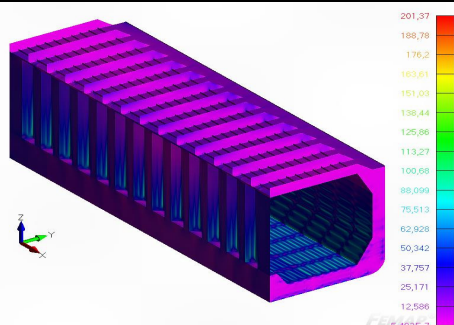

7. CONCLUSIONS

As a result of the FEM analysis, the areas with voltage concentrators that could not be highlighted after pre-dimensioning in POSEIDON were highlighted.

Based on the above obtained results, a series of conclusions can be drawn regarding the structural resistance of the vessel for the studied cases: still water, wave, sagging and hogging.

In areas where stress concentrators exceed the allowable flow value of steel $R_{eH} = 315 \text{ N/mm}^2$, it is possible to choose a steel with a higher quality, AH36 or A420, with flow limit $R_{eH} = 355 \text{ N/mm}^2$ and $R_{eH} = 420 \text{ N/mm}^2$ having tested the resistance to shock at a temperature of $\pm 0^\circ\text{C}$, or thicknesses of sheets and profiles larger than those dimensioned in the sample shall be adopted.

In order to reduce the tensions in the extreme fibers, it is possible to use the welding of flat strips around the technological cuts, these having the role of taking over from the loads of the stiffening elements.

Another way to eliminate areas with stress concentrators is to add stiffening ribs between the profiles.

The results obtained using this method can be used to optimize the structural resistance of naval structures.

From the following analyzes we can see that following the changes on the structure, the stresses that appear in the model for the analysis in still water and sagging are satisfactory according to the classification company DNV GL. For analysis on the hogging, where the highest values appear that exceed the allowable stresses imposed by the rules, the excessive stresses can be easily reduced using stiffening ribs on floors.

In all areas where higher stresses occur compared to the rest of the model, it is possible to intervene on the structure with elements with relatively low costs, but positively influence the resistance of the vessel.

8. REFERENCES

- [1] Cook, R. D., *Finite Element Modeling for Stress Analysis*, Wiley, New York, 1995.
- [2] Cristea A.G., *Contribuții privind optimizarea structurilor de navă*, Teză de doctorat, Galați, 2014
- [3] Jonathan Whiteley, *Finite Element Methods*, Ed. Springer International Publishing AG, 2007
- [4] x x x – Siemens PLM Software Inc., „FNN, Femap/NX Nastran users' manual,” 2020
- [5] x x x – DNV GL, Part 3, Chapter 7, Section 3, 2021
- [6] x x x – DNV, Poseidon User Manual, v.21.4
- [7] x x x – DNV rules for classification, Ships (RU-SHIP), <https://www.dnvgl.com/rules-standards/>
- [8] x x x – „Common Structural Rules for Bulk Carriers and Oil Tankers”, 1 Jan. 2020
- [9] <http://www.iacs.org.uk/publications/common-structural-rules/csr-for-bulk-carriers-and-oil-tankers/>
- [10] <http://www.imo.org/en/OurWork/Safety/Cargoes/CargoesInBulk/Pages/IBC-Code.aspx>
- [11] x x x – FEMAP 12.0.1a / NX NASTRAN User's Guide, UGS Corporation / Siemens PLM Software Inc., 2021

Paper received on November 20th, 2022