

IMPROVING SPECIFIC POWER CONSUMPTION FOR MECHANICAL MIXING OF THE FEEDSTOCK IN A BIOGAS FERMENTER BY MECHANICAL DISINTEGRATION OF LIGNOCELLULOSE BIOMASS

LUKÁŠ KRÁTKÝ*, TOMÁŠ JIROUT

Czech Technical University in Prague, Faculty of Mechanical Engineering, Department of Process Engineering, Technická 4, 166 07 Prague 6, Czech Republic

* corresponding author: Lukas.Kratky@fs.cvut.cz

ABSTRACT. Lignocellulose biomass particles in a biogas fermenter batch either sediment towards the bottom of the vessel or rise towards the batch surface, where they float and form a compact thick scum. These processes have a basically negative influence on batch homogeneity, on evenness of the batch temperature field, on the removal of biogas bubbles from the liquid batch, and also on mass transfer among the microorganisms. These issues result in inefficient usage of the energy potential of the biomass, and lead to low biogas yields. Good mixing of the bioreactor batch is very important for stabilizing the anaerobic digestion process. The aims of our study were to evaluate the impact of the disintegration and hydration of wheat straw on the hydrodynamic behaviour and on the specific power consumption for mechanical mixing of a wheat straw-water suspension. On the basis of the experimental results, it was concluded that both hydration and mechanical disintegration of lignocellulose biomass significantly improve the homogeneity and the pumpability of biomass-water batches. Wheat straw hydration by itself reduces the specific power consumption for batch mixing by 60 % in comparison with untreated straw. In addition, mechanical disintegration reduces the specific power consumption by at least 50 % in comparison with untreated hydrated straw.

KEYWORDS: fermenter, lignocellulose biomass, mixing, specific power consumption, wheat straw.

1. INTRODUCTION

Anaerobic digestion of organic wastes, residues and energy crops offers a very interesting option for generating biogas and also for reducing the amount of wastes that need to be disposed of. Methane-rich biogas has a high potential to replace natural gas, or it can be used as a feedstock for producing of chemicals and other materials [1]. Biogas production has also been evaluated as one of the most energy-efficient and environmentally beneficial technologies for bio-energy production [2]. Many types and concepts of agricultural biogas plants are currently applied, but an anerobic fermenter remains the crucial element in any kind of anaerobic technology. The vertical stirred tank fermenter is the most widely-used reactor configuration employed for wet anaerobic fermentation [3]. Batch mixing by filling in new substrate, by thermal convention flow, and by raising gas bubbles is usually not sufficient for an agricultural biogas fermenter. In addition, untreated or unprocessed lignocellulose biomass feedstock is bulky, difficult to feed into the fermenter, and floats on the batch surface, where it almost always forms a compact thick scum [1]. Active batch mixing therefore needs to be implemented in order to bring the microorganisms into contact with the new feedstock, to facilitate the upflow of gas bubbles, to achieve constant temperature conditions throughout the fermenter, to prevent particle sedimentation

on the bottom of the vessel, and to prevent particle floating and scum formation on the surface of the batch [1, 4, 5].

Up to 90 % of biogas plants use mechanical stirring equipment [1]. Mechanical mixing systems for biogas fermenters are based on the use of impellers, which can be categorized according to their revolutions as slow-running or fast-running. Fast-running impellers run mostly 1–10 times per day with agitation times of 5–60 min, whereas slowly rotating paddles mainly run continuously [2, 3]. Submerged motor propeller stirrers are most often applied. They can be adjusted to the height, to the tilt, and to the side [2]. Depending on the size and the substrate type of the fermenter, multistage mixing systems with up to four impellers in a vertical stirred tank fermenter are needed in order to prevent floating scum and sediments [1, 2]. If a fermenter is operated at a high solid concentration, slowly rotating paddle stirrers are preferred, with a horizontal, vertical, or diagonal axis and large scale paddles [1, 5]. Axial stirrers are mounted on shafts that are centrally installed on the ceiling of the digester. They form a steady stream in the digester that flows from the bottom up to the walls, resulting in very efficient homogeneity of solid substrates with manure or recycled process water. The typical size of a completely mixed fermenter is in the range from 1000 to 4000 m³ reactor volume [1]. The specific power consumption of a central mixing system

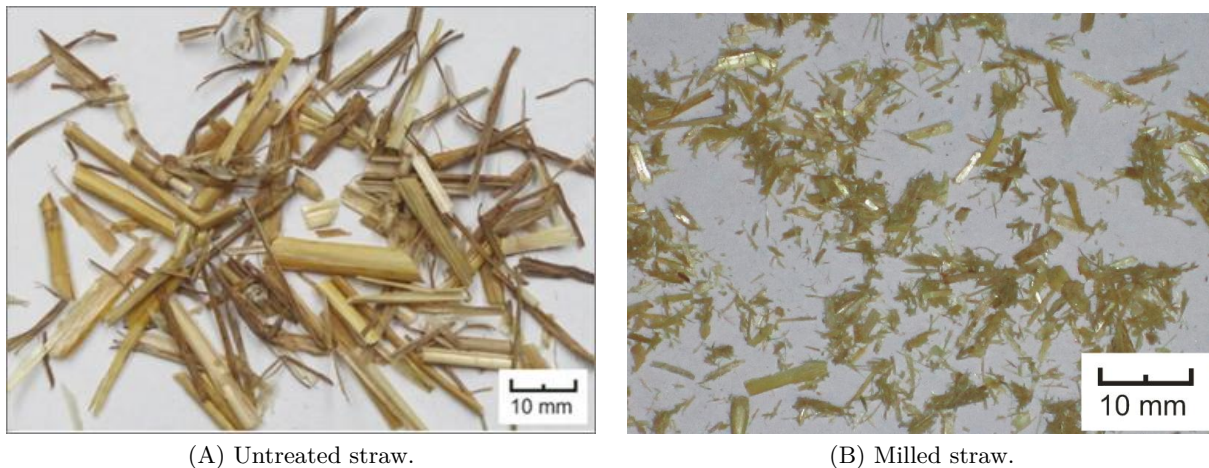

(A) Untreated straw.

(B) Milled straw.

FIGURE 1. The wheat straw particle sizes used in the experiments.

equipped with fast running impellers is usually in the range of $40\text{--}70\text{ W m}^{-3}$, and the specific power consumption of slowly-rotating paddle stirrers is about 10 W m^{-3} [5].

Good mixing of a biogas reactor batch is very important in order to stabilize the anaerobic digestion process. On the basis of the information above, it was supposed that biomass hydration and biomass size reduction would prevent lignocellulose particles sedimentating or floating on the batch surface, would improve batch pumpability, would reduce the impeller rotational speed for sufficient batch homogeneity, and would therefore also reduce the specific consumption for mixing. The aims of our study were therefore to evaluate the impact of lignocellulose biomass pre-treatment by mechanical disintegration and the influence of lignocellulose biomass hydration on the hydrodynamic behaviour and also the specific power consumption for mechanical mixing of a lignocellulose biomass-water suspension.

2. MATERIALS AND METHODS

2.1. RAW MATERIAL

Wheat straw was used in the experiments. Untreated straw $40\text{--}200\text{ mm}$ in length was cut in the field by a combine harvester, and collected and stored indoors in containers at ambient temperature for 4 years before the tests. The total solid content was determined to be 93% wt., and the volatile solid content was 88% wt. The total solid content was investigated by drying 5 reference samples in a KBC-25W oven overnight at a temperature of $105\text{ }^\circ\text{C}$. The volatile solid content was investigated by burning dried reference samples in an LE 09/11 furnace at the temperature of $550\text{ }^\circ\text{C}$ up to constant mass of the samples. The mass of the material was measured using an SDC31 analytic balance.

To be able to evaluate the impact of wheat straw pre-treatment by mechanical disintegration, and the impact of wheat straw hydration, on the hydrodynamic behaviour of a mechanically mixed straw-water

batch, the length of the untreated straw had to be reduced with the respect to the experimental layout of mixing system. The reduced untreated straw length was intended to provide a pulpy substance in an aqueous suspension, but at the same time to prevent the suction area of the impeller becoming blocked. Two reference straw samples of different length were used in the experiments, see Fig. 1. The first reference sample comprised untreated straw particles approximately 30 mm in length, see Fig. 1A. This length was achieved by cutting the untreated straw by hand, using scissors. The second reference sample was pre-treated straw, which was reduced in size by mechanical disintegration. The untreated straw was first hydrated in hot water at a temperature of $40\text{ }^\circ\text{C}$ for 20 minutes. Moisture content of 40% wt. achieved for the wheat straw. Then the wet wheat straw was mechanically disintegrated using a Retting mill [6] to straw particle sizes less than 10 mm , see Fig. 1B. The Retting mill is a new type of shredder, which is efficiently and continuously able to reduce wet fibrous biomass in size [7]. The two reference samples were dried, and were used to prepare the tested suspensions.

2.2. MIXING SYSTEM

All experiments were carried out in a glass cylindrical vessel with a flat bottom. The diameter of the vessel was equal to $D = 300\text{ mm}$, and the liquid level was $H = D$, see Fig. 2A. Four radial baffles $b = 0.1D$ in width were used in the experimental layout. A pitched six-blade turbine $d = 100\text{ mm}$ in diameter and with blade width $h = 0.2d$ was used in the experiments, see Fig. 2B. The height of the impeller above the bottom of the vessel varied during the experiments in the heights of $H_2 = 1d$ and $H_2 = 2d$. The impeller was operated to pump the suspension both down towards the bottom of the vessel and up towards the surface.

2.3. SUSPENSIONS

Three types of suspensions were used in the experiments. The suspensions were prepared from water

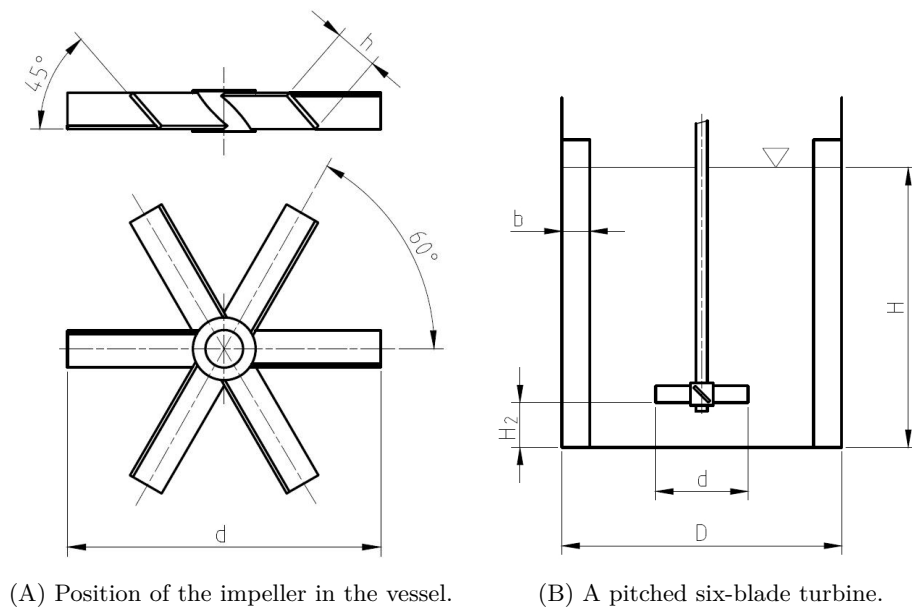

(A) Position of the impeller in the vessel. (B) A pitched six-blade turbine.

FIGURE 2. Experimental layout.

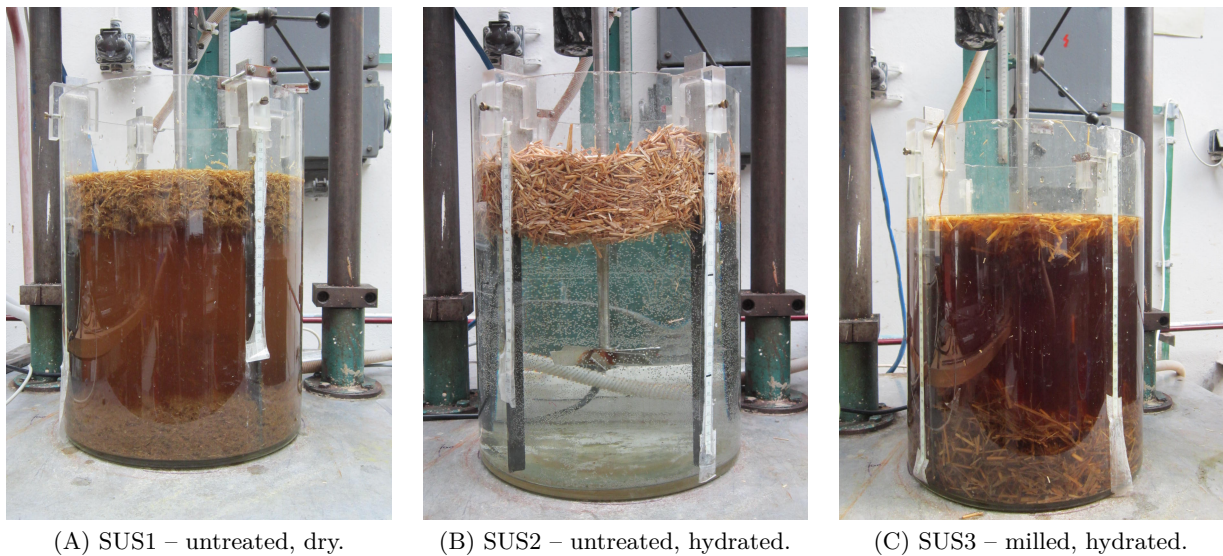

(A) SUS1 – untreated, dry. (B) SUS2 – untreated, hydrated. (C) SUS3 – milled, hydrated.

FIGURE 3. Behaviour of stationary wheat straw in a non-mixed aqueous suspension.

and untreated straw (SUS1), from untreated hydrated straw (SUS2) and from milled hydrated straw (SUS3), all with 1% wt. of total solids of straw. The mass of the material was measured using a Kern FKB laboratory balance.

The behaviour of suspension SUS1 in the vessel in the non-mixed steady state was that all straw particles floated on the surface of the batch due to the density of the straw, which was lower than the density of the liquid. These straw particles therefore created a compact floating scum on the surface of the batch, see Fig. 3A. Suspension SUS2 comprised untreated straw particles, also 30 mm in length. However, the untreated straw was first hydrated in water at a process temperature of 60 °C for residence time of 1 hour before it was used. Suspension SUS3 comprised milled straw particles less than 10 mm in length. These particles were also first

hydrated in water under a processing temperature of 60 °C for residence time of 1 hour before it was used. As is shown in Figs. 3B and 3C, straw hydration caused partial sedimentation of the material in the vessel in the non-mixed steady state. However, a certain proportion of the straw, which was lighter than the liquid, again rose to the surface of the batch, where it formed a floating scum.

3. FLUID FLOW PROPERTIES OF A MILLED AND HYDRATED WHEAT STRAW-WATER SUSPENSION

3.1. RHEOLOGICAL PROPERTIES

The rheological properties for SUS3 (a milled and hydrated wheat straw suspension) were determined on the basis of a measurement of the power consumption

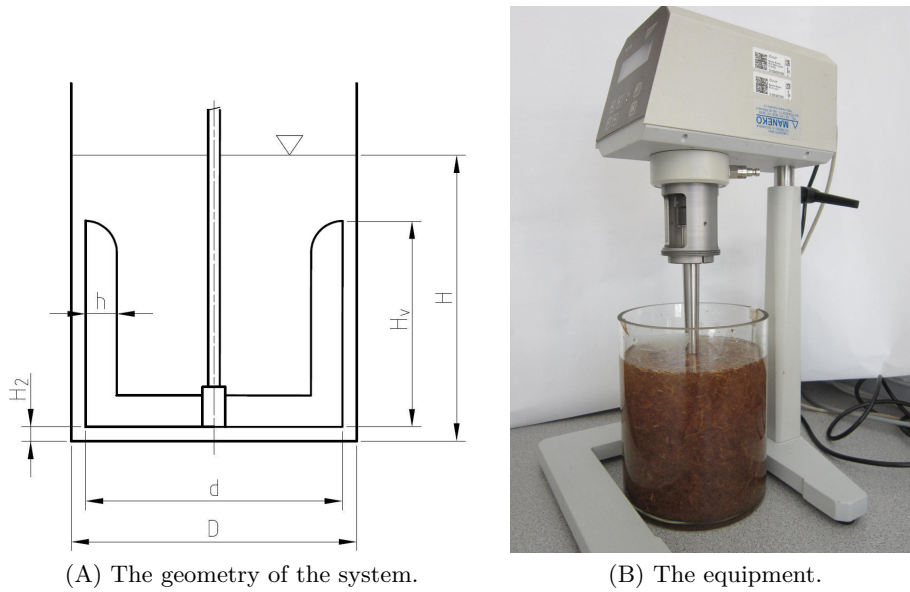

FIGURE 4. Experimental setup for the investigation of rheological properties.

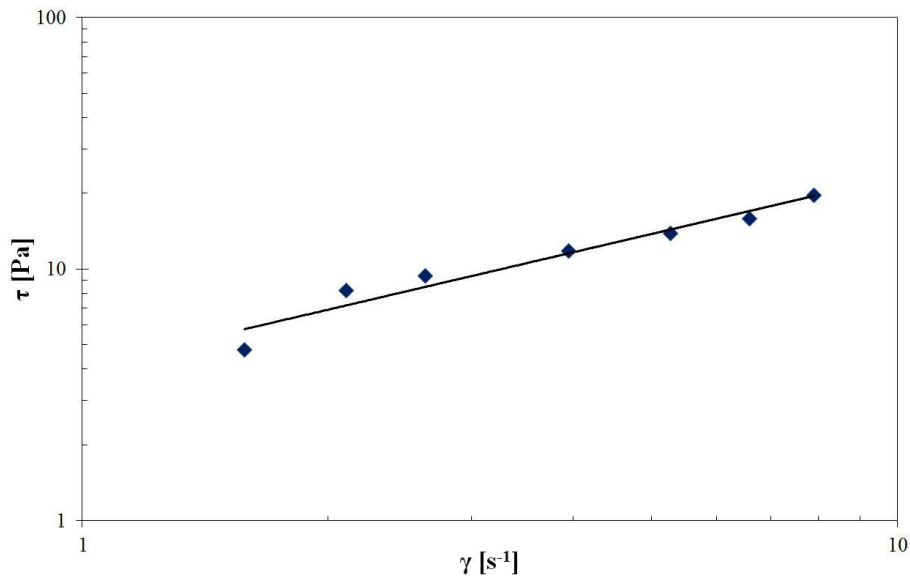

FIGURE 5. Dependence of shear stress on shear flow of suspension SUS3.

for a stirred impeller with a defined power characteristic. The experiments were carried out in a glass cylindrical vessel with a flat bottom 150 mm in inner diameter D , and the liquid level was $H = D$. A standardised anchor agitator with $D/d = 1.11$, $h/d = 0.12$, $H_V/D = 0.8$ and $H_2/d = 0.055$ was used in the experiments, see Fig. 4. Sufficient homogeneity of the batch mixing was achieved during the experiments in the creeping flow regime.

An RC20 Rheometer was used for the torque measurement. The rheometer makes direct measurements of torque M_K for adjusted impeller speed n . On the basis of this data, power consumption P was calculated as follows:

$$P = 2\pi n M_K. \tag{1}$$

It was also necessary to evaluate dimensionless power

number P_O for an investigation of the rheological properties of a mixed batch:

$$P_O = \frac{P}{\rho n^3 d^5}. \tag{2}$$

Based on knowledge of the power characteristic for the anchor impeller, which is expressed by the correlation equation published e.g., in [8], the corresponding Reynolds number Re values were determined by comparing the calculated P_O values with the characteristic. Then, using the Reynolds number values, the effective viscosity μ_{ef} was calculated as follows:

$$Re = \frac{\rho n d^2}{\mu_{ef}} \quad \text{therefore} \quad \mu_{ef} = \frac{\rho n d^2}{Re}. \tag{3}$$

It is generally known that the effective viscosity value is in accordance with the apparent viscosity value η

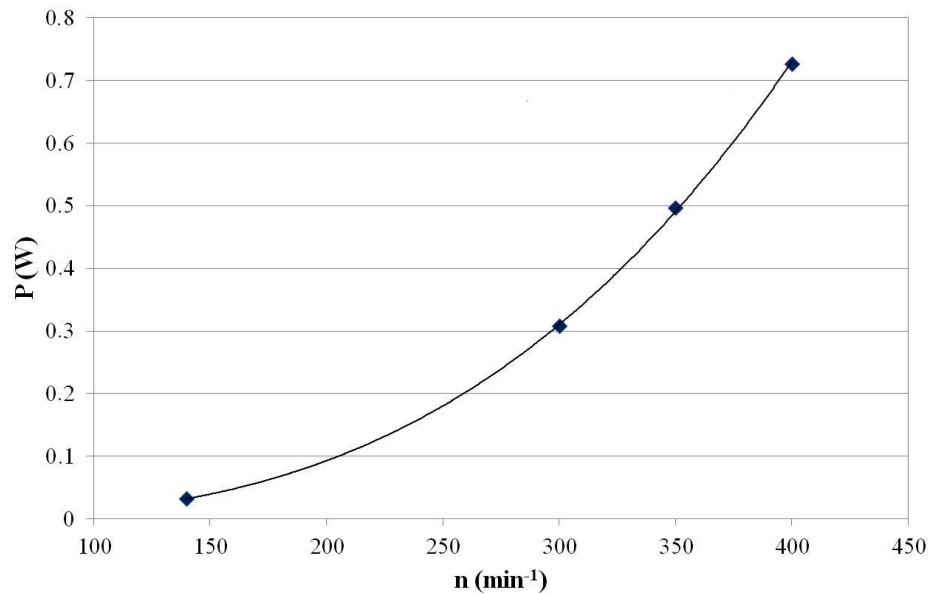

FIGURE 6. Dependence of power consumption on impeller speed.

at effective shear rate γ , which can be calculated on the basis of Metzner and Otto [8]:

$$\gamma = kn. \quad (4)$$

The k value generally depends both on the type of impeller and on the geometrical configuration of the mixing system. A k value equal to 15.8 is given for this configuration [8]. Based on these calculations, the dependence of shear stress on shear rate was plotted according to this equation:

$$\tau = K\gamma^m, \quad (5)$$

see Fig. 5.

A power-law model was used to describe the rheological properties of the wheat straw-water mixing system. Using the least square method, the consistency coefficient and the power-law index were calculated for the power-law rheological model, as follows:

$$\tau = 4.0735\gamma^{0.76}. \quad (6)$$

The rate of reliability R was equal to 0.97. The results clearly show that suspension SUS3 evinces non-Newtonian behaviour that is characterized by a consistency coefficient K of 4.07 Pa s^m and a dimensionless power-law index m of 0.76.

3.2. AN INVESTIGATION OF THE FLUID FLOW REGIME

The fluid flow regime is generally dependent both on the rheological properties of the batch and on the set up of the process parameters and the geometry of the mixing system. As has been shown, the milled and hydrated straw in a suspension evinced non-Newtonian behaviour. However, this property strongly affects the effective viscosity value, and thereby the power consumption during mixing. It is generally known that

the fluid flow in a batch depends on the Reynolds number, which is defined according to (3). Three types of fluid flow during mixing are known, i.e., creeping flow, transitional flow and turbulent flow. To be able to evaluate the existence of turbulent or creeping flow during batch mixing, the following considerations were taken into account. The power consumption generally depends on the power number, the density of the suspension, the impeller speed and the impeller diameter:

$$P = P_O \rho n^3 d^5. \quad (7)$$

According to the theory of mixing [8], the power number is inversely proportional to the Reynolds number during the creeping flow regime:

$$P_O = \frac{A}{Re}. \quad (8)$$

Using the definition of the Reynolds number in (3), where the effective viscosity is replaced by the power-law model

$$\mu_{\text{ef}} = K\gamma^{m-1} \quad (9)$$

and the shear rate is replaced by (4), the dependence of the power consumption on the impeller revolutions and on the impeller diameter is derived:

$$P = Bn^{1+m}d^3, \quad (10)$$

where constant B is defined as

$$B = AKk^{m-1}. \quad (11)$$

Based on the derived formula (9) and assuming the same geometry of the mixing system, it was concluded that the power consumption generally depends on the $(1+m)$ th power of the impeller revolutions during creeping fluid flow, i.e., on the revolutions powered to 1.76 for the tested batch. However, the power number is constant in the turbulent

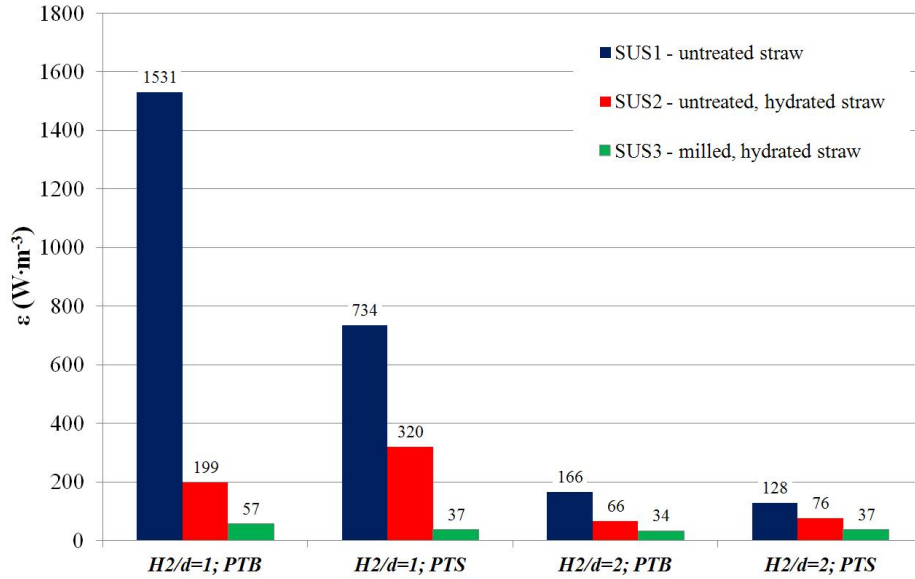

FIGURE 7. A comparison of the specific power consumption levels for the tested configurations and suspensions. PTB – the impeller pumps towards the bottom of the vessel; PTS – the impeller pumps towards the surface of the batch

fluid flow regime [8], so the power consumption is dependent on the impeller revolutions to the power of three.

The fluid flow regime in the batch was experimentally verified on the basis of these formulations. Taking into account the complete geometry of the tested mixing system described in section 2.2, the fluid flow regime was investigated for a baffled glass cylindrical vessel 150 mm in diameter equipped with a six pitched-blade turbine. A high-precision RC20 Rheometer was used for the torque measurements. Several powers were calculated by (1) by measuring the torque M_K for the adjusted impeller speed n . The impeller speeds were chosen for the state when sustainable batch homogeneity was reached.

The dependence of power consumption on impeller revolutions is depicted in Fig. 6. Using the LSM method, the power-law dependence of power consumption on impeller speed was fitted to the data. The regression equation of the power-law curve showed that the power consumption depends on the impeller revolutions powered to 2.98 with a rate of reliability equal to 1. Finally, the exponent with a value of 2.98 fully corresponds with turbulent flow regime theory, where a theoretical value of 3 is defined. We will now use the theory for scaling up according to the specific power, defined as follows:

$$nd^{2/3} = \text{const.} \quad (12)$$

On the basis of this formula, it is clear that a higher Reynolds number was reached in the vessel 300 mm in diameter than in the vessel 150 mm in diameter. All the experiments in the 300 mm vessel were therefore shown to have been carried out in a turbulent fluid flow regime.

4. RESULTS AND DISCUSSION

The specific power consumption was determined on the basis of the findings for the minimum impeller rotational speed for sufficient batch homogeneity and for the corresponding torque. The turbulent suspension flow was studied visually during batch mixing on the bottom of the vessel, at the level of the suspension along the baffles, and also on the batch surface. Sufficient batch homogeneity was defined as the state in which the straw particles do not remain for a short time period (approximately 2 s) at all the places mentioned above. The minimum impeller rotational speed for sufficient batch homogeneity was recorded as soon as sufficient batch homogeneity was reached. The impeller rotational speed was measured using a Siemens 1XP8001 electronic counter, and the minimum impeller revolutions for sufficient batch homogeneity were visually determined with accuracy of $\pm 5\%$. The torque was measured by a DR1 torsion shaft angle sensor, manufactured by Lorentz MessTechnik. The data was recorded using an A/D converter to the PC, and was recalculated using the calibration function to the torque values. Based on knowledge of the minimum impeller rotational speed for batch homogeneity n_M and on knowledge of the corresponding torque M_{KM} , the power and also the specific power consumption were calculated:

$$P_M = 2\pi n_M M_{KM}, \quad (13)$$

$$\epsilon = \frac{P_M}{V}. \quad (14)$$

A comparison of the specific power consumption on the suspension type of mixing system and on the geometrical configuration is shown in Fig. 7. Figure 8 shows the state of the suspension at the minimum impeller rotational speed for sufficient batch

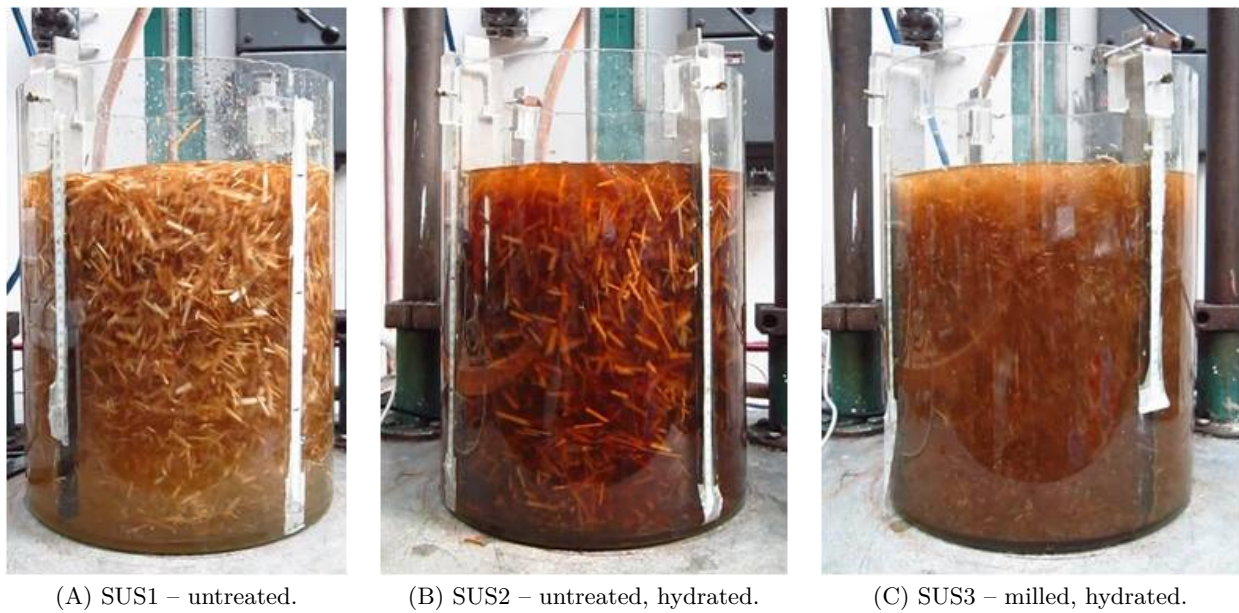

FIGURE 8. The homogenized batch at $H_2/d = 2$ with the impeller pumping to the batch surface.

homogeneity for the configuration of the mixing system $H_2/d = 2$ and with the impeller pumping to the batch surface. The maximum specific power consumption value of 1531 W m^{-3} was reached during mixing of suspension SUS1 (untreated straw) for the bottom pumping impeller located at a height of $H_2/d = 1$. The reason is that the wheat straw particles floated only on the batch surface (Fig. 3A). A very high impeller revolution of 730 min^{-1} was therefore needed to drag them from the surface into the liquid batch and to achieve sufficient batch homogeneity.

The maximum specific power consumption value of 321 W m^{-3} was reached while mixing suspension type SUS2 (untreated, hydrated straw) for the impeller pumping to the batch surface and its location at a height of $H_2/d = 1$. Sufficient batch homogeneity was observed at an impeller rotational speed of 402 min^{-1} . On the basis of a visual study of the mixed batch, it was observed that partial plugging of the impeller suction area, caused by a high local concentration of solid phase, was the main influence on the specific power consumption value. However, if the impeller pumped to the bottom of the vessel, the main limitation on achieving sufficient batch homogeneity was getting the floating straw at the batch surface into the liquid level. No straw sedimentation was observed at the bottom of the vessel for an impeller revolution of 150 min^{-1} , but the suspension flow in the vessel did not affect the flow around the batch surface. The size of the primary circulation loop was gradually increased with increasing impeller revolutions, and more intensive turbulent macro vortices were gradually generated. The floating straw was therefore dragged from the surface into the liquid batch at impeller revolution 307 min^{-1} , with corresponding specific power consumption of 199 W m^{-3} .

Based on the comparison of the specific power consumptions on the suspension type and on the geometrical configuration of mixing system (Fig. 7), it can be concluded that the low energy demanding configuration of the presented mixing system has the impeller located at a height of $H_2/d = 2$. The main factor, which has a strong influence on the specific power consumption value, is the hydrodynamic action of the impeller in the presence of solid phase. The turbulent vortices that are formed close to the batch surface around the impeller easily that the floating straw particles are got into the liquid level. However, if the impeller is located at a height of $H_2/d = 1$, a very high impeller revolution is needed to generate these vortices around the batch surface. Based on a comparison of the data for the position of the impeller at a height of $H_2/d = 2$, it can be concluded that pumping to the bottom of the vessel and to the batch surface have practically no influence on the specific power consumption. The measured specific power consumptions were 166 W m^{-3} for SUS1 (untreated straw), 66 W m^{-3} for SUS2 (untreated, hydrated straw), and 34 W m^{-3} for SUS3 (milled, hydrated straw).

However, all specific power consumptions mentioned above are slightly higher than real values. It was visually observed that both the non-milled and the milled straw particles had a tendency to cover the impeller blades. This effect primarily caused an increase in fluid flow resistance that leads to an increase in power. However, the effect of centrifugal forces effectively removed the straw particles from the blades. Based on this information, it can generally be concluded that straw hydration reduces the specific power consumption by 60 % for untreated straw, while a combination of straw pre-treatment by mechanical disintegration and by hydration decreases the specific power con-

sumption by 80 % for untreated straw. Mechanical disintegration itself decreases the specific power consumption by 50 %, at least for untreated hydrated straw.

5. CONCLUSIONS

Based on the experimental results, it has been concluded that both hydration and mechanical disintegration of lignocellulose biomass significantly decreased the specific power consumption for achieving a homogeneous biomass-water suspension.

- Hydration and mechanical disintegration of lignocellulose biomass significantly improve the homogeneity and pumpability of biomass-water batches.
- A milled and hydrated wheat straw-water suspension evinces non-Newtonian behaviour with a power-law index equal to 0.76.
- Straw hydration by itself decreases the specific power consumption by 60 % for untreated straw.
- Combined straw pretreatment by mechanical disintegration and by hydration reduces the specific power consumption by 80 % for untreated straw.
- Mechanical disintegration by itself reduces the specific power consumption by at least 50 % for untreated hydrated straw.

LIST OF SYMBOLS

A	constant [-]
b	baffle width [m]
B	constant [Pa s^m]
d	impeller diameter [m]
D	vessel diameter [m]
H	height of a liquid level [m]
h	width of a blade [m]
H_2	height of the impeller above the bottom [m]
H_V	height of the impeller [m]
k	Metzner and Otto constant [-]
K	consistency coefficient [Pa s^m]
m	power-law index [-]
M_K	torque [Nm]
M_{KM}	torque minimum impeller rotational speed for batch homogeneity [Nm]

n	rotational speed of impeller [s^{-1}]
n_M	minimum impeller rotational speed for batch homogeneity [s^{-1}]
P	power consumption [W]
P_M	power consumption at minimum impeller rotational speed for batch homogeneity [W]
P_o	power number [-]
R	rate of reliability [-]
Re	Reynolds number [-]
V	volume of suspension [m^3]
μ_{ef}	effective viscosity [Pa s]
γ	shear rate [s^{-1}]
ϵ	specific power [W m^{-3}]
η	apparent viscosity [Pa s]
ρ	density of suspension [kg m^{-3}]
τ	shear stress [Pa]

REFERENCES

- [1] Weiland, P.: Biogas production: current state and perspectives. *Applied Microbiology and Biotechnology*, 2010, 85, pp. 849-860.
- [2] Schulz, H., Eder, B.: *Bioplyn v praxi*. Ostrava: HEL s.r.o., 2004. 167 pp. ISBN 80-86167-21-6.
- [3] Pandey, A.: Handbook of plant-based biofuels. In CRC Press, New York, 2009, ISBN 978-1-56022-175-3, 297 pp.
- [4] Chanakya, H.N., Srikumar, K.G., Anand, V., Modak, J., Jagadish, K.S.: Fermentation properties of agro-residues, leaf biomass and urban market garbage in a solid phase biogas fermenter. *Biomass and Bioenergy*, 1999, 16, pp. 417-429.
- [5] Jirout, T., Rieger, F., Moravec, J.: Studie míchání anaerobních fermentačních reaktorů na BPS. [Research Report]. Prague: Czech Technical University in Prague, Faculty of Mechanical Engineering, Department of Process Engineering, 2008, 22 pp.
- [6] Krátký, L., Jirout, T. and Nalezenc, J.: Lab-scale technology for biogas production from lignocellulose wastes. *Acta Polytechnica*. 2012, 52 (3) pp.54-59.
- [7] Slabý, F., Nalezenc, J., Krátký, L., Maroušek J.: Retting mill. [Patent]. Industrial Property Office of Czech Republic, 26080, 2013-11-11.
- [8] Rieger, F., Novák, V., Jirout, T.: Hydromechanické procesy II. CTU in Prague: CTU Publishing House, 2005. 167 p. ISBN 80-01-03302-3, (in Czech).