



The Effect of Surface Roughness on Thermohydrodynamic Performance in Misaligned Journal Bearings

Basim Ajeel Abass

Mustafa Mohammed K.

Department of Mechanical Engineering/ College of Engineering/ University of Babylon

(Received 19 July 2009; Accepted 7 September 2010)

Abstract

In this work an approach has been developed to investigate the influence of surface roughness on thermohydrodynamic performance in aligned and misaligned journal bearings by considering an average flow model and deriving the shear flow factor for various roughness configurations, similar to the pressure flow factor. An average Reynolds equation for rough surfaces is defined in term of pressure and shear flow factors, which can be obtained by numerical flow simulation, though the use of measured or numerically generated rough surfaces. Reynolds, heat conduction and energy equations are solved simultaneously by using a suitable numerical technique (Finite Difference Method) to obtain the pressure and temperature distribution through the oil film thickness of the journal bearing. These equations are obtained for isotropic surfaces and for surfaces with directional patterns. The flow factors for these surfaces are expressed as empirical relations in term of normalized oil film thickness (h/σ) and surface characteristic (γ) defined as the ratio of x and z correlation lengths. The results of this approach showed increase in load carrying capacity and maximum pressure and decrease in maximum temperature in the case of stationary surface roughness (rough bearing and smooth journal) with transverse pattern. The results obtained through this work have been compared with that published by other works and found to be in a good agreement.

Keywords: Thermohydrodynamic performance, surface roughness, misalignment, journal bearing

1. Introduction

The study of surface roughness effects in micro machine design has intensively been the subject of investigations in recent years. Over the past several years, the incorporation of many physical effects into the analysis of fluid-film bearings has provided much more realistic performance data. In particular, the familiar assumptions of a smooth surface, isothermal operating condition, aligned journal bearing and Newtonian behavior of the lubricant can no longer be employed to accurately predict the performance of fluid-film bearing system, as in [1, 2, 3, 4, 5] to study a thermohydrodynamic (THD) performance in aligned journal bearings. Oscar Pinkus [6] and Safar [7] studied the analysis of misaligned grooved journal bearings and energy loss from misalignment state. Buckholz [8] and Jiin-Yah Jang [9] investigated the effect of misalignment on load for thermal and adiabatic

condition by using non-Newtonian lubricant. Moreover, to improve the performance of journal bearings, a surface finish that can enhance the performance under their geometric and operating conditions has to be sought. Hence studies that deal with the influence of surface roughness on performance of journal bearing systems are more appropriate.

In recent years, a considerable amount of research activities have been devoted to the study of surface roughness effects on the performance of hydrodynamic journal bearing systems. The influence of surface roughness in most of these studies has been included using either stochastic model (limited to two specific types of roughness structures; one dimensional ridges oriented either transversely or longitudinally) or average flow model proposed by Nadir Patir and H.S.Cheng [10, 11]. Zhang et.al [12] presented a transient (THD) analysis of mixed lubrication. The Reynolds equation has been modified for one-

dimensional transverse , isotropic and longitudinal roughness patterns , and then extended this work for the case of a non-Newtonian lubricant obeying power law model for dynamic load . These studies have been limited to the effect of one-dimensional surface roughness on the performance of hydrodynamic journal bearings. The limiting cases of roughness found in real engineering surfaces and hence, many investigators used the modified form of Patir and Cheng average flow model to include the combined influence of more realistic three-dimensional (3D) surface roughness and thermal behavior of lubricant on the performance of hydrodynamic journal bearings. Nagaraju et.al [13] investigated the influence of surface roughness on Newtonian and non-Newtonian lubricant in hybrid journal bearing by solving the average Reynolds equation, heat conduction and energy equations simultaneously using numerical method and showed the thermal effect for each moving and stationary surface roughness. Kim and Kim [14] showed the effect of surface roughness on THD analysis with film condition and predicting the bearing parameters such as pressure and temperature distribution in lubricating films between the stationary and moving surfaces. Fanghui Shi et.al [15] studied a mixed – TEHD model for journal bearing conformal contacts by using a thermal process for temperature analysis and a thermal –elastic process for deformation calculations. Ramish et.al. [16] studied the THD analysis of submerged oil journal bearings considering surface roughness effect. A parametric study of steady state behavior has been carried out .A numerical study deals with the improvement of the THD performance of a 100mm plain journal bearing subjected to a constant misalignment torque under steady state conditions found by Bouyer and Fillon [17]. Thermohydrodynamic analysis of surface roughness in the flow field has been carried out by Joon and Joo [18]. The pressure and temperature distribution in the lubricating film of a lemon-bore journal bearing has been studied by Ron et.al. [19]. In the present work , application of mathematical model (average flow model) and a general solution scheme are presented to include the combined effect of surface roughness and misalignment of journal axes on the performance of the journal bearing lubricated with Newtonian lubricant. The average Reynolds equation, heat conduction and energy

equations are simultaneously solved through a suitable numerical technique for transverse, isotropic and longitudinal surface patterns orientation.

2. Governing Equations and Bearing Geometry

A schematic diagram for the journal bearing used in the present analysis with the suitable coordinates has been shown in Fig (1). It can be shown in this figure the effect of surface roughness of both journal bearing surfaces on the oil film thickness. The following equations are used to solve the problem of the present work.

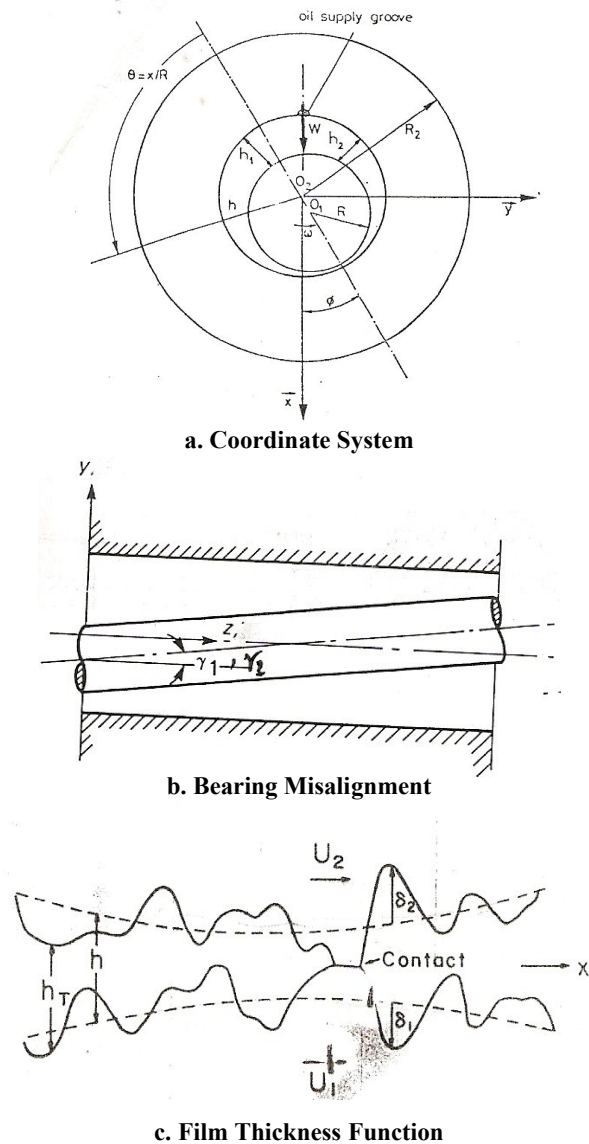

Fig.1. Geometrical Configuration of Rough Misaligned Journal Bearing.

3. Average Reynolds Equation

For the laminar flow of an incompressible, Newtonian lubricant and for thermal condition in the clearance space between rough surfaces of journal and bearing, the modified average Reynolds equation for misaligned journal bearing in non-dimensional form can be written as in [13, 15, 20]:

$$\frac{\partial}{\partial \theta} \left\{ \phi_x \bar{h}^3 \bar{F} \frac{\partial \bar{p}}{\partial \theta} \right\} + \left(\frac{R}{L} \right)^2 \frac{\partial}{\partial Z} \left\{ \phi_z \bar{h}^3 \bar{F} \frac{\partial \bar{p}}{\partial Z} \right\} = \frac{\partial}{\partial \theta} \{ \bar{G} \bar{h}_r \} + \frac{1}{\Lambda} \frac{\partial}{\partial \theta} \{ \bar{G} \phi_s \} \quad \dots(1)$$

where

$$\bar{F} = \frac{\int_0^1 (A_1 A_2 - A_3 A_4) dy}{A_4}$$

$$\bar{G} = \frac{\int_0^1 (A_2) d\bar{y}}{A_4} \quad \text{and}$$

$$A_1 = \int_0^1 \frac{y}{\bar{\mu}} d\bar{y} \quad , \quad A_2 = \int_0^{\bar{y}} \frac{1}{\bar{\mu}} d\bar{y} \quad ,$$

$$A_3 = \int_0^{\bar{y}} \frac{\bar{y}}{\bar{\mu}} d\bar{y} \quad , \quad A_4 = \int_0^1 \frac{1}{\bar{\mu}} d\bar{y}$$

The empirical relations of pressure flow factors (ϕ_x, ϕ_y) are expressed as in Patir and Cheng [11]

$$\phi_x = 1 - C e^{-r(\Lambda \bar{h})} \quad \text{for} \quad \gamma \leq 1$$

$$\phi_x = 1 + C (\Lambda \bar{h})^{-r} \quad \text{for} \quad \gamma > 1 \quad \dots(2a)$$

And

$$\phi_z (\Lambda \bar{h}, \gamma) = \phi_x \left(\Lambda \bar{h}, \frac{1}{\gamma} \right) \quad \dots(2b)$$

where C and r are the constants that can be found in table (1) or as expressed in [10]. And γ is the surface pattern parameter.

The shear flow factor (ϕ_s) in journal bearing system is expressed as [11]

$$\phi_s = (2Vrj - 1) \Phi_s \quad \dots(3a)$$

Φ_s is a positive function of h/σ and the surface pattern parameter of a given surface.

$$\Phi_s = B_1 (\Lambda \bar{h})^{\alpha_1} e^{-\alpha_2 (\Lambda \bar{h}) + \alpha_3 (\Lambda \bar{h})^2} \quad \text{for} \quad \Lambda \bar{h} \leq 5$$

$$\Phi_s = B_2 e^{-0.25 (\Lambda \bar{h})} \quad \text{for} \quad \Lambda \bar{h} > 5 \quad \dots(3b)$$

$B_1, B_2, \alpha_1, \alpha_2$ and α_3 are constants and can be obtained from Patir and Cheng [11] or table (2).

Table 1, Coefficients of Pressure Flow Factors

Γ	C	r	Range
1/6	1.38	0.42	H>1
1	0.9	0.56	H>0.5
6	0.52	1.5	H>0.5

Table 2, Coefficients of Shear Flow Factors

Γ	B_1	α_1	α_2	α_3	B_2
1/6	1.962	1.08	0.77	0.03	1.754
1	1.899	0.98	0.92	0.05	1.126
6	1.290	0.62	1.09	0.08	0.388

4. Oil Film Thickness

The local oil film thickness h_T is defined as

$$h_T = h + \delta_1 + \delta_2 \quad \dots(4)$$

where (h) is the nominal oil film thickness (compliance) defined as the distance between the mean levels of the two surfaces. δ_1 and δ_2 are the random roughness amplitudes of the two surfaces measured from their mean levels. δ_1 and δ_2 are assumed to have a Gaussian distribution of heights with zero mean and standard deviations σ_1 and σ_2 respectively. The combined roughness $\delta = \delta_1 + \delta_2$ has a variance $\sigma = \sqrt{\sigma_1^2 + \sigma_2^2}$.

The ratio h/σ is an important parameter showing the effect of surface roughness. For $h/\sigma > 3$, fully lubrication occur in journal bearing system, the roughness become important as $h/\sigma \rightarrow 3$. As h/σ decrease under 3 asperities start interacting with each other and contact form.

The directional properties of roughness are described by a surface pattern parameter γ , It defined as the ratio of x and y correlation lengths:

$$\gamma = \frac{\lambda_{0.5x}}{\lambda_{0.5z}} \quad \dots(5)$$

γ can be interpreted as the length to width ratio a representative asperity, purely transverse, isotropic and purely longitudinal roughness structures correspond to $\gamma = 0, 1, \infty$, respectively. For the journal bearing system having Gaussian distribution of surface heights the expression for average fluid – film thickness (\bar{h}_T) in fully lubricated ($\Lambda\bar{h} \geq 3$) and partially lubricated ($\Lambda\bar{h} < 3$) regions in misaligned journal bearings is expressed as below.

$$\begin{aligned} \bar{h}_T &= \bar{h} & \text{for } \Lambda\bar{h} \geq 3 \\ \bar{h}_T &= \frac{\bar{h}}{2} \left[1 + \operatorname{erf} \left(\frac{\Lambda\bar{h}}{\sqrt{2}} \right) \right] + \frac{1}{\Lambda\sqrt{2\pi}} e^{-\frac{(\Lambda\bar{h})^2}{2}} & \text{for } \Lambda\bar{h} < 3 \end{aligned} \quad \dots(6)$$

Where \bar{h} is the nominal fluid-film thickness (the fluid-film thickness of smooth journal bearing system) and is introduced as:

- In alignment journal bearing system

$$\bar{h} = 1 + \varepsilon \cos \theta \quad \dots(7a)$$

- In misalignment journal bearing system

$$\bar{h} = \left\{ (1 + \varepsilon \cos \theta) - \bar{Z}\sigma_1^* \cos \theta + \bar{Z}\sigma_2^* \sin \theta \right\} \quad \dots(7b)$$

Where

$$\sigma_1^* = 2 \left(\frac{R}{c} \right) \left(\frac{L}{D} \right) \tan \gamma_1 \quad \dots(7c)$$

$$\sigma_2^* = 2 \left(\frac{R}{c} \right) \left(\frac{L}{D} \right) \tan \gamma_2 \quad \dots(7d)$$

Where γ_1, γ_2 are the tilting angles in vertical and horizontal direction of bearing as in [8, 9]

5. Heat-Conduction Equation

The temperature distribution through the solid bush can be evaluated by solving the heat-conduction equation. The steady state heat-conduction equation with no heat source in non-dimensional form can be written as [2]:

$$\frac{\partial^2 \bar{T}}{\partial \bar{r}^2} + \frac{1}{\bar{r}} \frac{\partial \bar{T}}{\partial \bar{r}} + \frac{1}{\bar{r}^2} \frac{\partial^2 \bar{T}}{\partial \theta^2} = 0 \quad \dots(8)$$

6. Energy Equation

When the misaligned journal bearing operated in a fully lubricated condition, the heat generated due to asperity contact can be neglected and only the heat generated due to viscous shear of the lubricant is considered. The non-dimensional form of energy equation with the assumption that the lubricant density and thermal conductivity remains constant is shown in [2, 6]:

$$\begin{aligned} \lambda_1 \left\{ \bar{u} \frac{\partial \bar{T}}{\partial \theta} \right\} + \lambda_1 \left\{ \frac{\bar{v}}{\bar{h}_T} - \bar{u} \frac{\bar{y}}{\bar{h}_T} \cdot \frac{\partial \bar{h}_T}{\partial \theta} - \left(\frac{R}{L} \right) \frac{\bar{y}}{\bar{h}_T} \cdot \frac{\partial \bar{h}_T}{\partial \bar{Z}} \right\} \frac{\partial \bar{T}}{\partial \bar{y}} \\ = \lambda_2 \frac{1}{\bar{h}_T^2} \frac{\partial^2 \bar{T}}{\partial \bar{y}^2} + \lambda_3 \frac{\bar{\mu}}{\bar{h}_T^2} \left\{ \left(\frac{\partial \bar{u}}{\partial \bar{y}} \right)^2 + \left(\frac{\partial \bar{w}}{\partial \bar{y}} \right)^2 \right\} \end{aligned} \quad \dots(9)$$

where :

$$\lambda_1 = \frac{\rho C_o U R}{K_{oil}}, \quad \lambda_2 = \left(\frac{R}{c} \right)^2 \quad \text{and}$$

$$\lambda_3 = \left(\frac{R}{c} \right)^2 \frac{\mu_{in} U^2}{K_{oil} T_{in}}$$

7. Fluid-Film Velocity Components

The flow of lubricant between two rough surfaces can be modeled by an equivalent flow model. The equivalent flow model is defined as two smooth surfaces separated by a clearance equal to the average gap (\bar{h}_T). Based on the equivalence of flow though the average fluid-film thickness and though the local fluid-film thickness, a group of new pressure flow factors (ϕ'_X, ϕ'_Y) and a shear flow factor (ϕ'_S) can be evaluated as follows:

$$\phi'_X = \frac{\bar{h}^3}{\bar{h}_T^3} \phi_X; \quad \phi'_Y = \frac{\bar{h}^3}{\bar{h}_T^3} \phi_Y \quad \text{and} \quad \phi'_S = \phi_S \quad \dots(10)$$

The velocity components in circumferential and axial direction in non-dimensional form are expressed as [13]:

$$\bar{u} = \phi'_x \bar{h}_T^2 \frac{\partial \bar{p}}{\partial \theta} \left\{ \int_0^{\bar{y}} \frac{\bar{y}}{\bar{\mu}} d\bar{y} - \frac{\int_0^1 \frac{\bar{y}}{\bar{\mu}} d\bar{y} \cdot \int_0^{\bar{y}} \frac{1}{\bar{\mu}} d\bar{y}}{\int_0^1 \frac{1}{\bar{\mu}} d\bar{y}} \right\} + \frac{\int_0^{\bar{y}} \frac{1}{\bar{\mu}} d\bar{y}}{\int_0^1 \frac{1}{\bar{\mu}} d\bar{y}} + \frac{\phi'_s}{\Lambda \bar{h}_T} \frac{\int_0^{\bar{y}} \frac{1}{\bar{\mu}} d\bar{y}}{\int_0^1 \frac{1}{\bar{\mu}} d\bar{y}}$$

$$\bar{u} = \phi'_x \bar{h}_T^2 \frac{\partial \bar{p}}{\partial \theta} \left\{ A_3 - \frac{A_1 A_2}{A_4} \right\} + \frac{A_2}{A_4} + \frac{\phi'_s}{\Lambda \bar{h}_T} \frac{A_2}{A_4} \dots(11)$$

$$\bar{w} = \phi'_z \bar{h}_T^2 \frac{\partial \bar{p}}{\partial Z} \left(\frac{R}{L} \right) \left\{ \int_0^{\bar{y}} \frac{\bar{y}}{\bar{\mu}} d\bar{y} - \frac{\int_0^1 \frac{\bar{y}}{\bar{\mu}} d\bar{y} \cdot \int_0^{\bar{y}} \frac{1}{\bar{\mu}} d\bar{y}}{\int_0^1 \frac{1}{\bar{\mu}} d\bar{y}} \right\}$$

$$\bar{w} = \phi'_z \bar{h}_T^2 \frac{\partial \bar{p}}{\partial Z} \left(\frac{R}{L} \right) \left\{ A_3 - \frac{A_1 A_2}{A_4} \right\} \dots(12)$$

where \bar{u}, \bar{w} are the velocity components in circumferential and axial directions respectively.

The fluid-film velocity component across the fluid-film is obtained from the continuity equation and is expressed in non-dimensional form as:

$$\bar{v} = -\bar{h}_T \int_0^{\bar{y}} \left\{ \frac{\partial \bar{u}}{\partial \theta} + \left(\frac{R}{L} \right) \frac{\partial \bar{w}}{\partial Z} - \frac{\bar{y}}{\bar{h}_T} \cdot \frac{\partial \bar{h}_T}{\partial \theta} \frac{\partial \bar{u}}{\partial \bar{y}} \right\} d\bar{y} \dots(13)$$

8. Viscosity Equation

The viscosity of the lubricant was assumed to be variable across the film and a round the circumference. The variation of viscosity with the temperature is given by the following equation as described by [2]:

$$\bar{\mu} = k_o - k_1 \bar{T} + k_2 \bar{T}^2 \dots(14)$$

Where k_o, k_1 and k_2 are constant given in table (3) or as expressed in [2,4,5]

Table 3, Geometric and Operation Parameters of the Bearing

Bearing Length	L = 0.08 m
External bearing radius	R _{bout} = 0.1 m
Journal radius	R = 0.05 m
Radial clearance	C = 0.000152 m
Eccentricity ratio	ε = 0.62
Surface roughness parameter	Λ = 10
Surface pattern parameter for transverse, isotropic and longitudinal roughness pattern	γ = 1/6, 1, 6 respectively
Inlet lubricant temperature	T _{in} = 40 C°
Ambient temperature	T _a = 40 C°
Inlet pressure	P _{in} = 70000 pa
Rotation speed	S = 2000 rpm
Lubricant density	ρ = 860 Kg/m ³
Lubricant specific heat	C _o = 2000 J/Kg.C
Bush convection heat transfer	h _c = 80 W/m ² .C
Bush thermal conductivity	K _b = 250 W/m .C
Lubricant thermal conductivity	K _{oil} = 0.13 W/m . C
Tilt angles in vertical and horizontal direction	γ _{1}, γ₂ = 0.0002, 0.00005 rad}
Viscosity coefficient (k _o , k ₁ , k ₂)	3.287, 3.064, 0.777 respectively

**(The symbols (Gm) and (S) in all figures below refer to surface roughness pattern γ and rotational speed of journal U respectively) .

9. Boundary Conditions

To analyze the thermohydrodynamic performance in rough and misaligned journal bearing system, the following boundary conditions can be used.

• Lubricant flow field

- At the journal bearing edges $\bar{Z} = 0$ and $\bar{Z} = 1 \rightarrow \bar{p} = \bar{p}_{atm} = 0.0$
- At the Cavitations zone $\frac{\partial \bar{p}}{\partial \theta} = 0.0$ and $\bar{p} = 0.0$ (Reynolds boundary conditions)

• Thermal field

1. The temperature across the oil film in the grove zone known as mixed temperature (T_{mix}) is assumed to be constant and can be estimated as described by [2, 16]:

$$T_{mix} = \frac{Q_{rec} \bar{T}_r + Q_{in} \bar{T}_{in}}{Q_{rec} + Q_{in}} \quad \dots(15a)$$

Where

\bar{T}_r = recirculation temperature

\bar{T}_{in} = inlet oil temperature

Q_{in} = supply oil flow rate m³/sec

Q_{rec} = recirculation flow rate (m³/sec) and is expressed as follow :

$$Q_{rec} = LUC \int_0^1 \bar{u} \bar{h}_r \bar{d}y \quad \dots(15b)$$

2. The heat flux continuity on the surface between the bush and the oil film interface which yields to the following boundary condition as described by [2, 13]:

$$\left. \frac{\partial \bar{T}}{\partial \bar{r}} \right|_{\bar{r}=1} = - \frac{K_{oil}}{K_b} \cdot \frac{r_{bin}}{c} \cdot \frac{1}{\bar{h}_r} \cdot \left. \frac{\partial \bar{T}}{\partial \bar{y}} \right|_{\bar{y}=0} \quad \dots(16a)$$

Where $\bar{r} = \frac{r_b}{r_{bin}}$

3. The boundary condition which referred to the heat losses by free convection [2]:

$$\left. \frac{\partial \bar{T}}{\partial \bar{r}} \right|_{\bar{r}=\bar{r}_{bout}} = - \frac{h_{conv}}{K_b} r_{bin} (\bar{T}_{bo} - \bar{T}_a) \quad \dots(16b)$$

10. Solution Procedure

Thermohydrodynamic analysis of a rough misaligned journal bearing system required the simultaneous solution of governing equations with appropriate boundary conditions described above. These equations are numerically solved using a finite difference method, with appropriate iterative scheme. The solution procedure is as follows:

1. Input the operating conditions, characteristic properties, initial pressure and temperature distributions of oil film. Compute initial value of attitude angle (ϕ) as:

$$\phi = \tan^{-1} \frac{\pi \sqrt{1 - \varepsilon^2}}{4 \varepsilon} \quad \dots(17)$$

Compute the nominal, average film thickness and pressure, shear flow factors from equations (2, 3, 6, 7).

2. Evaluate the viscosity distribution and the values of (A_1, A_2, A_3, A_4)
3. New pressure distribution can be obtained by an iterative scheme with successive under relaxation method which was employed to solve the average Reynolds equation .The iterations stops if convergence criterion (error) reaches (10^{-4}). New value of attitude angle (ϕ) is calculated as follows:

$$\phi = \tan^{-1} \left(\frac{\bar{W}_t}{\bar{W}_r} \right) \quad \dots(18)$$

Where \bar{W}_r and \bar{W}_t are the radial and the tangential components of the load which can be expressed as:

$$\bar{W}_r = \int_0^1 \int_0^{2\pi} \bar{p} \cos \theta \cdot d\theta \cdot \bar{d}Z$$

$$\bar{W}_t = \int_0^1 \int_0^{2\pi} \bar{p} \sin \theta \cdot d\theta \cdot \bar{d}Z$$

The old and new attitude angle are compared. If the difference between angles is less than one degree then calculate velocity component using Eqs (11, 12, 13).

4. Calculate the mixing temperature from equation (15) and leakage flow rate as follows:

$$Q_1 = RUC \int_0^{2\pi} \int_0^1 \bar{w} \bar{h}_r \bar{d}y \cdot d\theta \quad \dots(19)$$

5. The heat transfer equation (8) and energy equation (9) with the boundary conditions are solved simultaneously. A direct iterative procedure with successive under relaxation has been adopted to get the temperature field through the oil film. The new oil-film temperature is used to compute a new viscosity field in step (2) which is subsequently used to solve the average Reynolds equation and simultaneous solutions for the equations are obtained iteratively until the converging criteria of the temperature for all points on the boundary between the oil film and the inner bush face is less than (10^{-6}). A computer program written in Fortran-90 has

been prepared to solve the governing equations of the problem. An average execution time of five minutes has been found suitable to execute the program. Figure (A-1) shows the program flow chart.

11. Results and Discussion

The results obtained through this work have been computed for the geometric and operating parameters of the bearing presented in table (3). The results obtained in the present work for smooth aligned journal bearing are compared to the experimental results obtained by J.Ferron et al [2] as shown in figures 2, 3, 4, 5 and 6, The maximum error for load carrying capacity is 3.5%, for maximum pressure 5% and for maximum temperature 3%. It seems from these figures that the results are in a good agreement. The above comparison represents a good verification to the computer program prepared to solve the problem of this work.

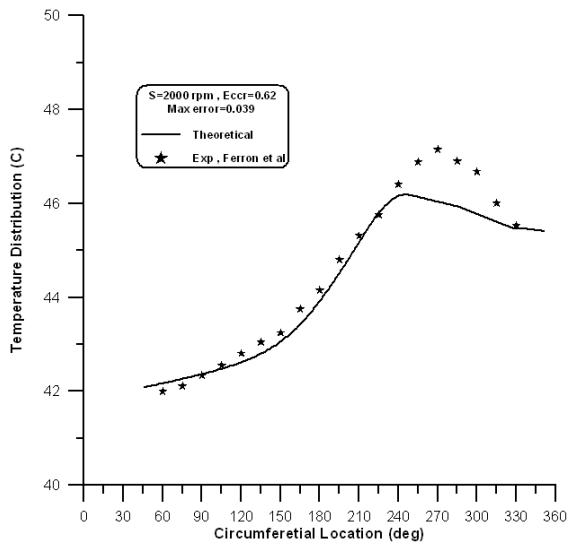

Fig.2. Temperature Distribution with Circumferential Location in Aligned Smooth Journal Bearing.

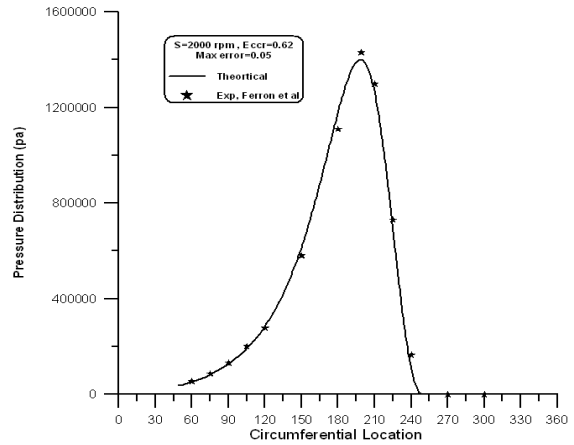

Fig.3. Pressure Distribution vs. Circumferential Location in Aligned Smooth Journal Bearing.

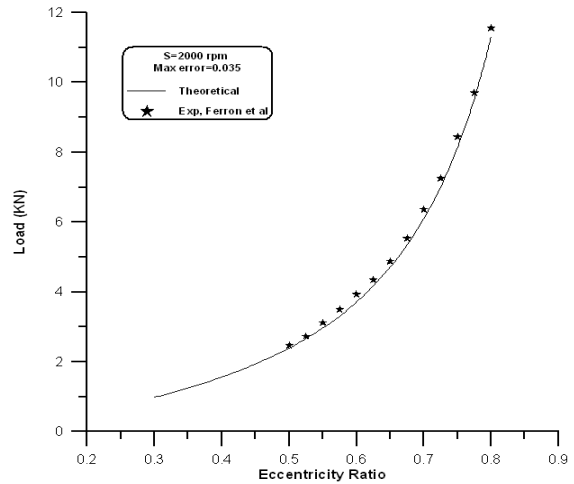

Fig.4. Load with Eccentricity Ratio in Aligned Smooth Journal Bearing.

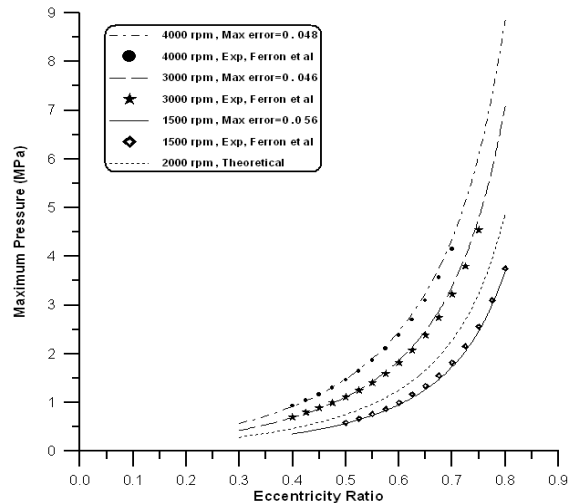

Fig.5. Maximum Pressure vs. Eccentricity Ratio in Aligned Smooth Journal Bearing.

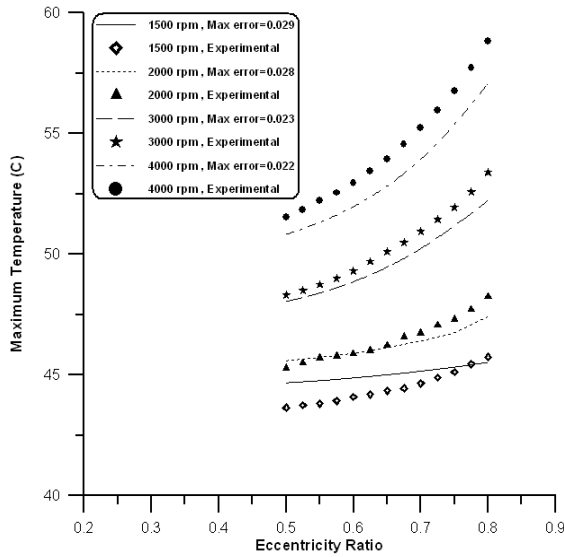

Fig.6. Maximum Temperature vs. Eccentricity Ratio in Aligned Smooth Journal Bearing.

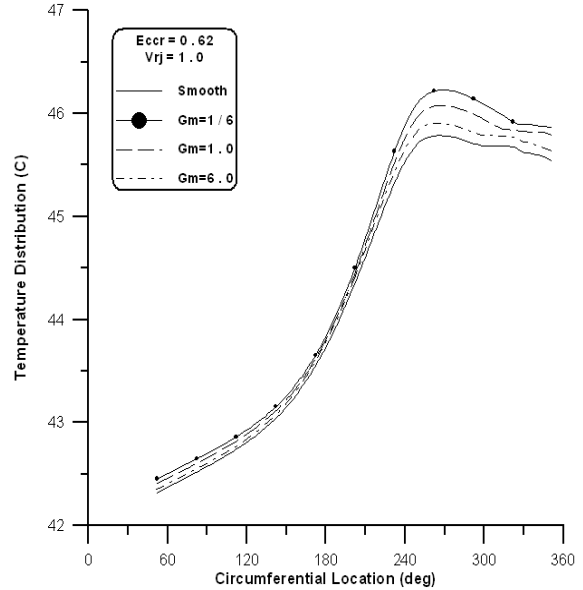

Fig.7. Temperature Distribution vs. Circumferential Location for Moving Roughness in Misalignment Journal Bearing.

Figures (7, 8) show the influence of surface roughness orientation γ and surface roughness characteristics of opposing surfaces (ie. variance ratio V_{rj}) on fluid-film temperature distribution (T) along the circumferential direction at an axial midplane ($\bar{Z} = 0.5$) and across the midfilm ($\bar{y} = 0.5$) in misaligned journal bearing. The moving roughness (rough journal and smooth bearing $V_{rj}=1.0$) provides increasing in circumferential fluid-film temperature distribution as compared to that obtained in smooth journal bearing, This is because the moving roughness have positive shear flow factor ϕ_s which increases the fluid-film velocity in the circumferential direction and consequently the viscous shear of lubricant, hence the fluid-film temperature increased. On the other hand the stationary roughness (rough bearing and smooth journal $V_{rj}=0.0$) reduces the fluid-film velocity in the circumferential direction (since ϕ_s is negative) causes a reduced fluid-film temperature. The transverse roughness pattern ($\gamma=1/6$) having a larger value of shear flow factor, provides maximum reduction and maximum increasing in the values of circumferential fluid-film temperature distribution in stationary and moving roughness cases respectively.

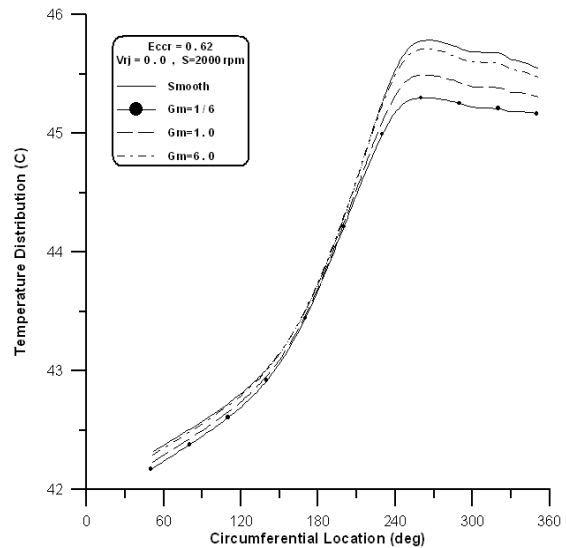

Fig.8. Temperature Distribution vs. Circumferential Location for Stationary Roughness in Misalignment Journal Bearing.

The influence of surface roughness on circumferential fluid-film pressure distribution at an axial midplane ($\bar{Z} = 0.5$) in misaligned journal bearing with stationary and moving surface roughness can be shown in figure (9), It can be deduced from this figure that the stationary roughness ($V_{rj}=0.0$) and transverse pattern ($\gamma=1/6$) combination increase the pressure as compared with smooth bearing.

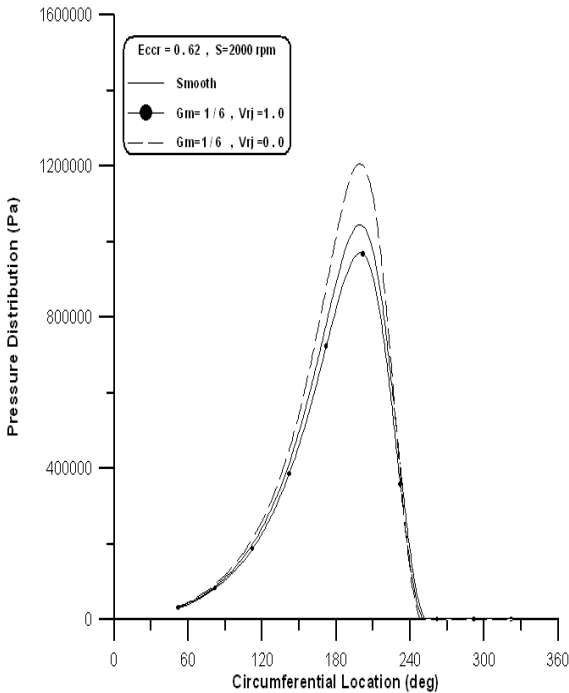

Fig.9. Pressure Distribution vs. Circumferential Location for Moving and Stationary Roughness in Misalignment Journal Bearing.

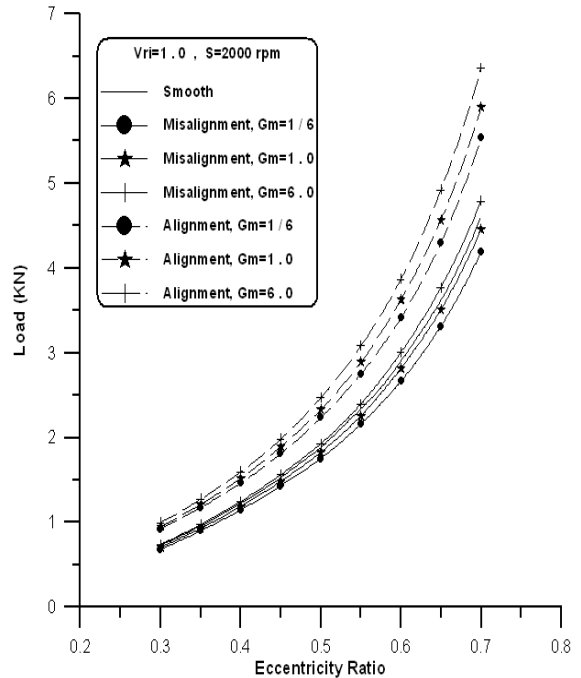

Fig.10. Load vs. Eccentricity Ratio for Moving Roughness in Alignment and Misalignment Journal Bearing.

Figures (10, 11) show the effect of surface roughness on load carrying capacity with increase eccentricity ratio in aligned and misaligned journal bearing for moving and stationary roughness. In case of the moving surface roughness in misaligned bearing the load carrying capacity increases with eccentricity ratio (in transverse and isotropic surface pattern). It is also clear that the load carrying capacity for the bearing with transverse and isotropic surface roughness is less than that in smooth journal bearing. This is because the shear flow factor in moving roughness is positive and this causes a decreased pressure and then the load of the bearing. In longitudinal pattern the increase with the eccentricity ratio is more than that in smooth bearing. In case of the stationary roughness the increase of the load with eccentricity ratio is more than that in smooth bearing this is because the negative shear flow factor. It can also be shown from these figures that the increase in load carrying capacity with the eccentricity ratio in case of moving and stationary roughness in aligned journal bearing is always higher than that obtained from misaligned journal bearing.

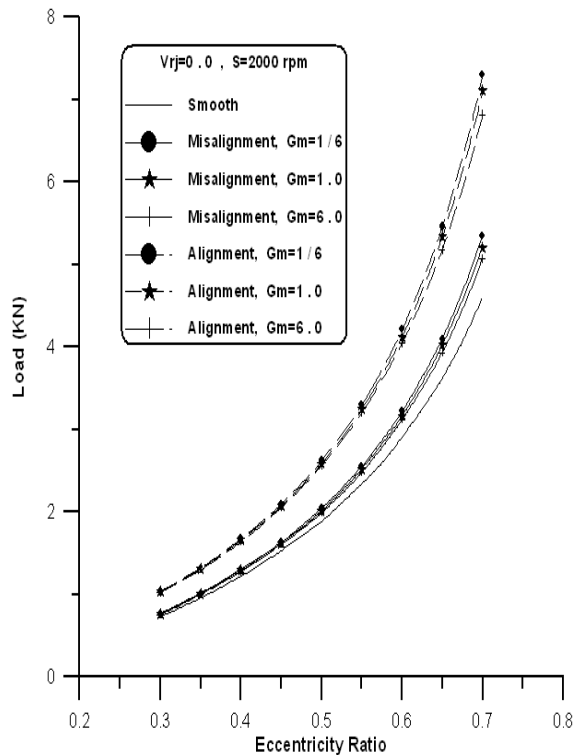

Fig.11. Load vs. Eccentricity Ratio for Stationary Roughness in Alignment and Misalignment Journal Bearing.

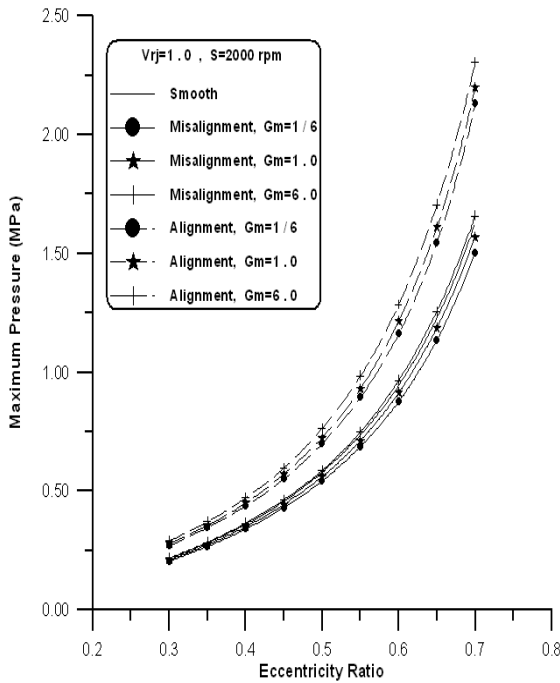

Fig.12. Maximum Pressure vs. Eccentricity Ratio for Moving Roughness in Alignment and Misalignment Journal Bearing.

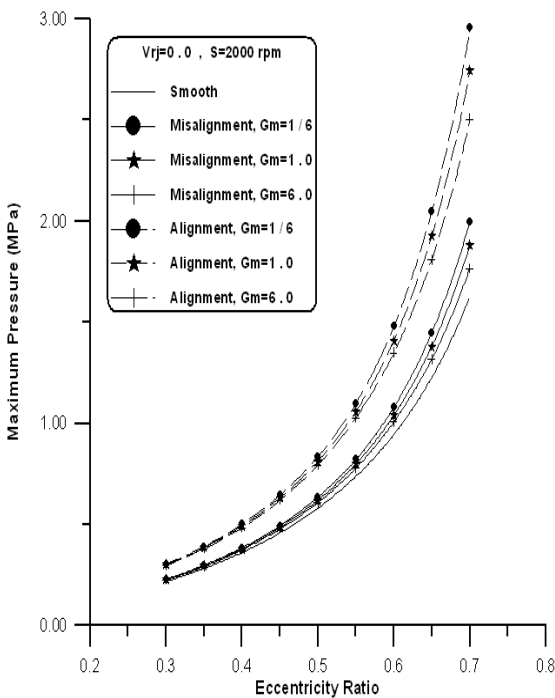

Fig.13. Maximum Pressure vs. Eccentricity Ratio for Stationary Roughness in Alignment and Misalignment Journal Bearing.

Figures (12, 13) show an increase of maximum pressure value with respect to eccentricity ratio under the effect of moving and stationary surface roughness for aligned and misaligned journal bearing. The increase of maximum pressure with the eccentricity ratio is less than that in smooth journal bearing for the moving roughness except of the longitudinal pattern ($\gamma=6$). It can also deduced from figure (13) that the maximum pressure of the oil is always higher for stationary surface roughness ($V_{rj} = 0.0$). This is attributed to the negative shear flow factor in this case, which causes higher viscosity and hence higher pressure. These figures also show that the maximum pressure decreases when the misalignment of the journal center has been considered. The decrease in maximum pressure has been calculated and found to be 48% for the bearing with moving roughness while it becomes 31% for the bearing with stationary roughness.

The maximum oil film temperature increases with increasing eccentricity ratio as shown in figures (14, 15). It is clear that the maximum temperature becomes higher when the moving surface roughness is considered. It can also be deduced from these figures that the maximum temperature for stationary roughness is lower than that obtained from smooth journal bearing. In alignment state the maximum temperature value is higher than that in misalignment bearing. This is due to the effect of reduction in pressure field. Figures (16, 17) show the effect of surface roughness on attitude angle in aligned and misaligned journal bearing. The attitude angle decreases with the increase of eccentricity ratio. The reduction of attitude angle with eccentricity ratio is less than that in smooth journal bearing for the case of moving surface roughness. This can be attributed to the reduction of the load in this case. In stationary roughness this reduction become more than that in smooth bearing because of the increasing in load.

Figures (18, 19) show that the side leakage flow rate increases with the eccentricity ratio for smooth, moving and stationary roughness in alignment and misalignment cases. Fig (18) shows that the oil side leakage flow rate is decreased when the moving surface roughness effect is considered. This is attributed to the positive shear flow factor ϕ_s which increased the mean recirculation flow rate. The mean recirculation flow rate is decreased and side leakage flow rate increased in the case of the bearing with stationary

roughness as shown in fig (19), which is attributed to the negative shear flow factor ϕ_s in this case.

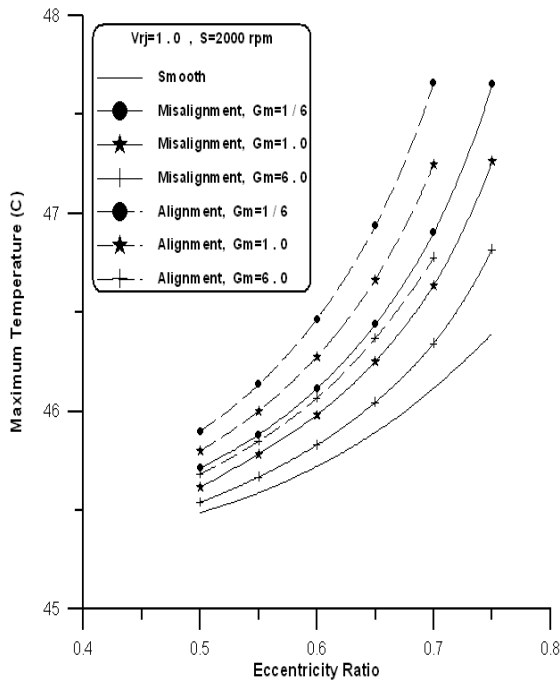

Fig.14. Maximum Temperature vs. Eccentricity Ratio for Moving Roughness in Alignment and Misalignment Journal Bearing.

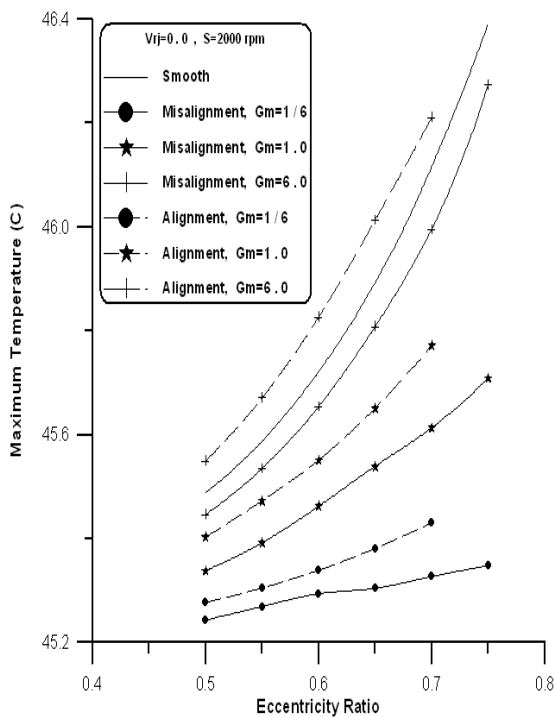

Fig.15. Maximum Temperature vs. Eccentricity Ratio for Stationary Roughness in Alignment and Misalignment Journal Bearing.

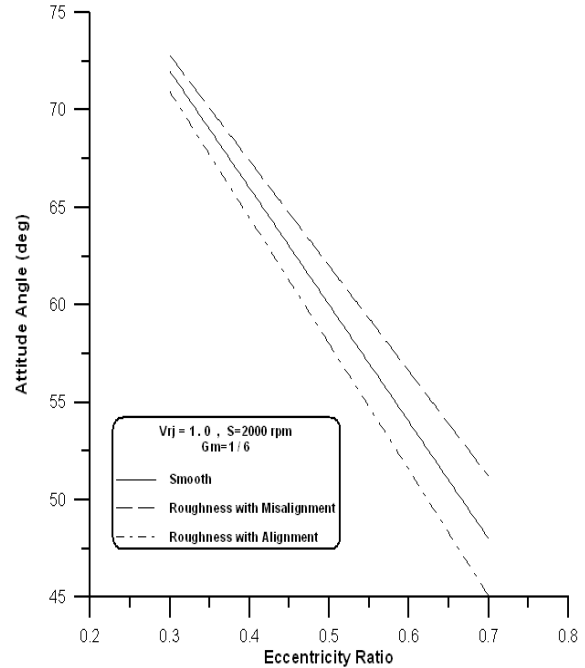

Fig.16. Attitude Angle vs. Eccentricity Ratio for Moving Roughness in Alignment and Misalignment Journal Bearing.

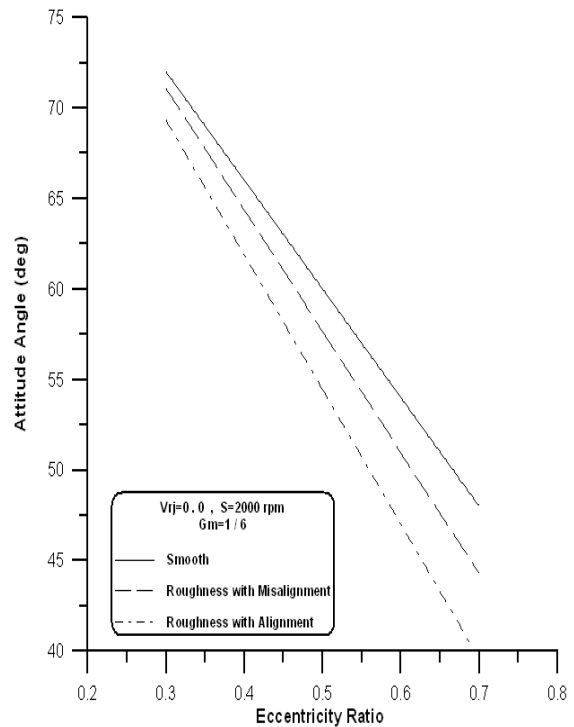

Fig.17. Attitude Angle vs. Eccentricity Ratio for Stationary Roughness in Alignment and Misalignment Journal Bearing.

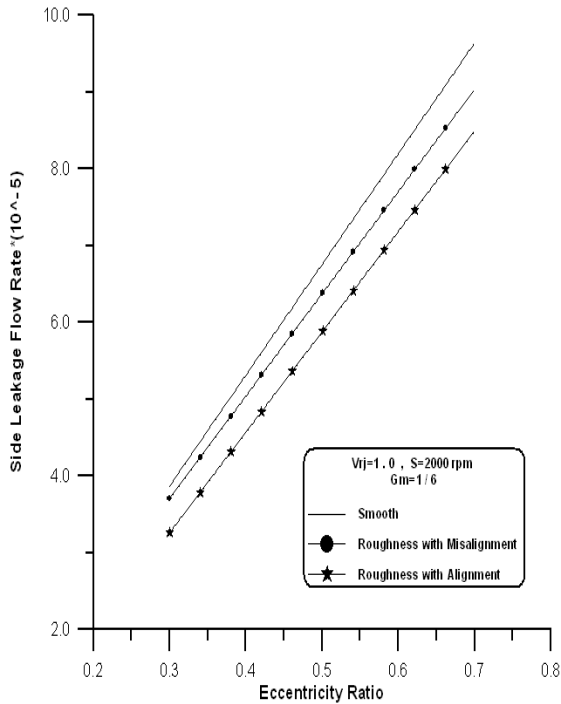

Fig.18. Side Leakage Flow Rate vs. Eccentricity Ratio for Moving Roughness in Alignment and Misalignment.

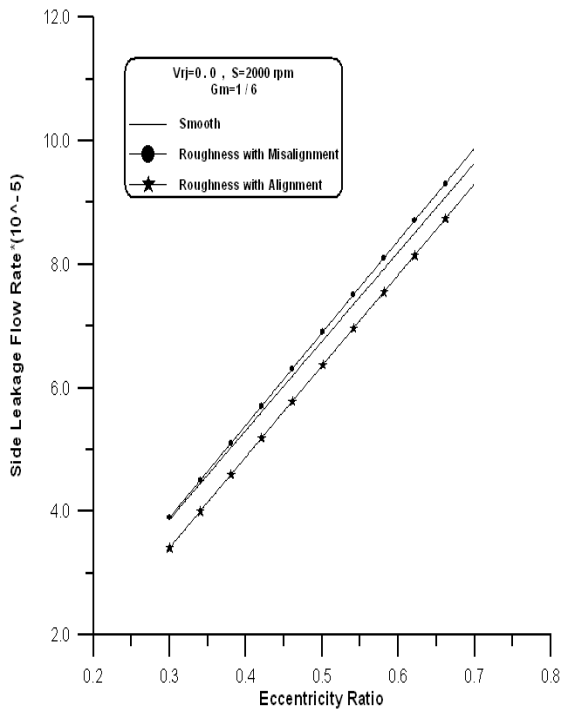

Fig.19. Side Leakage Flow Rate with Eccentricity Ratio for Stationary Roughness in Alignment and Misalignment.

12. Conclusions

The results presented in this study lead to the following conclusions:

1. The surface roughness characteristics of opposing surfaces (i.e., variance ratio, Vr_j) and roughness orientation (γ) play an important role in reducing or increasing fluid-film temperature. The stationary roughness with a transverse roughness pattern provides maximum reduction in fluid-film temperature.
2. Misalignment with surface roughness in journal bearing leads to decrease each of load, pressure and temperature as compared with the aligned journal bearing.
3. The loss in load-carrying capacity due to thermal effects can be partially retrieved from a suitable surface roughness combination. The stationary roughness (i.e., rough bearing and smooth journal) and transverse roughness pattern ($\gamma=1/6$) is suitable

Nomenclature

- $c =$ radial clearance (m)
- $Co =$ specific heat of lubricant J/Kg. °C
- $D =$ diameter of journal bearing (m)
- $\bar{F}, \bar{G} =$ non-dimensional integration functions of viscosity
- $h =$ nominal film thickness (m)
- $\bar{h} =$ non-dimensional nominal film thickness, $\bar{h} = h/c$
- $h_T =$ local film thickness in rough surfaces (m)
- $\bar{h}_T =$ average film thickness in rough surfaces
- $h_{conv} =$ convection heat transfer coefficient $W/m^2 \cdot ^\circ C$
- $k_{0,1,2} =$ viscosity coefficients
- $K_{oil} =$ thermal conductivity of the lubricant $W/m \cdot ^\circ C$
- $K_b =$ thermal conductivity of the bush $W/m \cdot ^\circ C$
- $L =$ journal bearing length (m)
- $\bar{p} =$ non-dimensional pressure :
- $$\bar{p} = \frac{P}{\mu_{in} UR / c^2}$$
- $Q_{rec} =$ recirculation flow m^3/sec

Q_{in} =	inlet flow in the bearing groove m ³ /sec
Q_1 =	side leakage flow rate m ³ /sec
R =	Radius of Journal (m)
\bar{T} =	non-dimensional fluid – film temperature
T_{in} =	inlet fluid temperature in the bearing groove °C
T_{mix} =	mixed temperature in a groove
\bar{T}_a =	non-dimensional ambient temperature °C
U =	journal rotational speed (rpm) or (S in all figures)
$\bar{u}, \bar{v}, \bar{w}$ =	non-dimensional components of the fluid velocity in the x, y and z direction, $\bar{u} = u/U$, $\bar{v} = vR/cU$, $\bar{w} = w/U$
V_{rj}, V_{rb} =	variance ratio of journal and bearing, $((\sigma_1, \sigma_2)/\sigma)^2$
\bar{W} =	non-dimensional applied load : $\bar{W} = \frac{W}{\mu_{in} UL(R/c)^2}$
x, y, z =	coordinate in circumferential , across film and axial direction respectively and in dimensional form
θ, \bar{y}, \bar{z} =	non-dimensional coordinates, $\theta = x/R, \bar{y} = y/h, \bar{z} = z/L$
δ_1, δ_2 =	random roughness amplitudes (m)
σ_1, σ_2 =	standard deviations
$\lambda_{0.5x}, \lambda_{0.5z}$ =	auto correlation lengths in x and z direction respectively
ϕ_x, ϕ_y =	pressure flow factors
ϕ_s =	shear flow factor
Λ =	surface roughness parameter, $\Lambda = c/\sigma$
σ_1^*, σ_2^* =	two independent misalignment parameters
γ_1, γ_2 =	tilt angles
$\bar{\mu}$ =	non-dimensional lubricant viscosity
ρ =	lubricant density (Kg/m ³)
μ_{in} =	inlet fluid viscosity in the bearing groove pa.s
ϕ =	attitude angle

13. References

- [1] B. C. Majumar, 1974, "The Thermo hydrodynamic Solution of Oil Journal Bearings", Wear, Vol. 31, PP. 287 – 294.
- [2] J. Ferron, J. Frene and R. Boncompain, 1983, "A Study of the Thermohydrodynamic Performance of a plain Journal Bearing Comparison Between Theory and Experimental", ASME J. Lubr. Technol., Vol. 105, PP. 422 – 428.
- [3] Junichi Mitsui, Yukio Hori and Masato Tanaka, 1986, "An Experimental Investigation on the Temperature Distribution in Circular Journal Bearings", ASME J. Tribol., Vol. 108, PP. 621 – 626.
- [4] Jun'ichi Mitsui, 1987, "A Study of Thermo hydrodynamic Lubrication in a Circular Journal Bearing", Tribol. International, Vol. 11, PP. 331 – 341.
- [5] H. H. OH and G. Paradissiadis, 1988, "Them hydrodynamic Analysis of Journal Bearings Considering Cavitation and Reverse Flow", ASME J. Tribol., Vol. 110, PP. 439 – 447.
- [6] Oscar Pinkus and S. S. Bupara, 1978, "Analysis of Misaligned Grooved Journal Bearings", ASME J. Lubr. Technol., Vol. 101, PP. 503 – 508.
- [7] Z. S. Safar, 1984, "Energy Loss due to Misalignment of Journal Bearings", Tribol. International, Vol. 03, PP. 107 – 110.
- [8] R. H. Buckholz and J. F. Lin, 1986, "The Effect of Journal Bearing Misalignment on Load and Cavitation for non-Newtonian Lubricants", ASME J. Tribol., Vol. 108, PP. 645 – 653.
- [9] Jiin-Yuh Jang and Chong- Ching Chang, 1987, "Adiabatic Solutions for A misaligned Journal Bearing with non-Newtonian Lubricants", Tribol. International, Vol. 09, PP. 267 – 275.
- [10] Nadir Patir and H. S. Cheng, 1978, "An Average Flow Model for Determining Effects of Three-Dimensional Roughness on Partial Hydrodynamic Lubrication", ASME J. Lubr. Technol., Vol. 100, PP. 12 – 17.
- [11] Nadir Patir and H. S. Cheng, 1979, "Application of Average Flow Model to Lubrication Between Rough Sliding Surfaces" ASME J. Lubr. Technol., Vol. 101, PP. 220 – 230.
- [12] Chao Zhang and H. S. Cheng, 2000, "Transient Non-Newtonian Thermohydrodynamic Mixed Lubrication of Dynamically Loaded Journal Bearings", Trans. ASME, Vol. 122, PP. 156 – 161.

- [13] T. Nagaraju , Satish C. Sharma and S. C. Jain, 2007, "Influence of Surface Roughness on Non-Newtonian Thermohydrostatic Performance of a Hole-Entry Hybrid Journal Bearing" ASME J. Tribol., Vol. 129, PP. 595 – 602.
- [14] J. H. Kim, S. K. Kim and J.-H. Kim, 2004, "The Influence of Surface Roughness on Thermohydrodynamic Analysis", Kookmin University
- [15] Fanghui Shi and Qian (Jane) Wang, 1998, "A Mixed – TEHD Model for Journal – Bearing Conformal Contacts – Part I: Model Formulation and Approximation of Heat Transfer Considering Asperity Contact", ASME J. Tribol., Vol. 120, PP. 198 – 205.
- [16] J. Ramesh, B.C. Majumdar and N.S.Rao, 1997, "Thermohydrodynamic analysis of submerged oil journal bearings considering surface roughness effects", Transactions of the ASME, Vol.119, January, PP. 100-106.
- [17] J. Bouyer and M. Fillon, 2003, "Improvement of the THD performance of a misaligned plain journal is bearing", Transactions of the ASME, Vol.125, PP.334-342.
- [18] Joon Hyun Kim and Joo-Hyun Kim, 2005, "Thermohydrodynamic analysis of surface roughness in the flow field", Journal of Tribology, Vol. 127, PP. 293-301.
- [19] Ron A.J. van Ostayen and Anton Van Beek, 2009, "Thermal modeling of the lemon-bore hydrodynamic bearing", Tribology International , Vol 42,PP.23-32.
- [20] Yansong Wang, Chao Zhang, Q. Jane Wang and Chih Lin, 2002, "Amixed – TEHD Analysis and Experiment of Journal Bearing under Severe Operating Conditions", Tribol. International, Vol. 35, PP. 395 – 407.

Appendix (A)
Program Flowchart

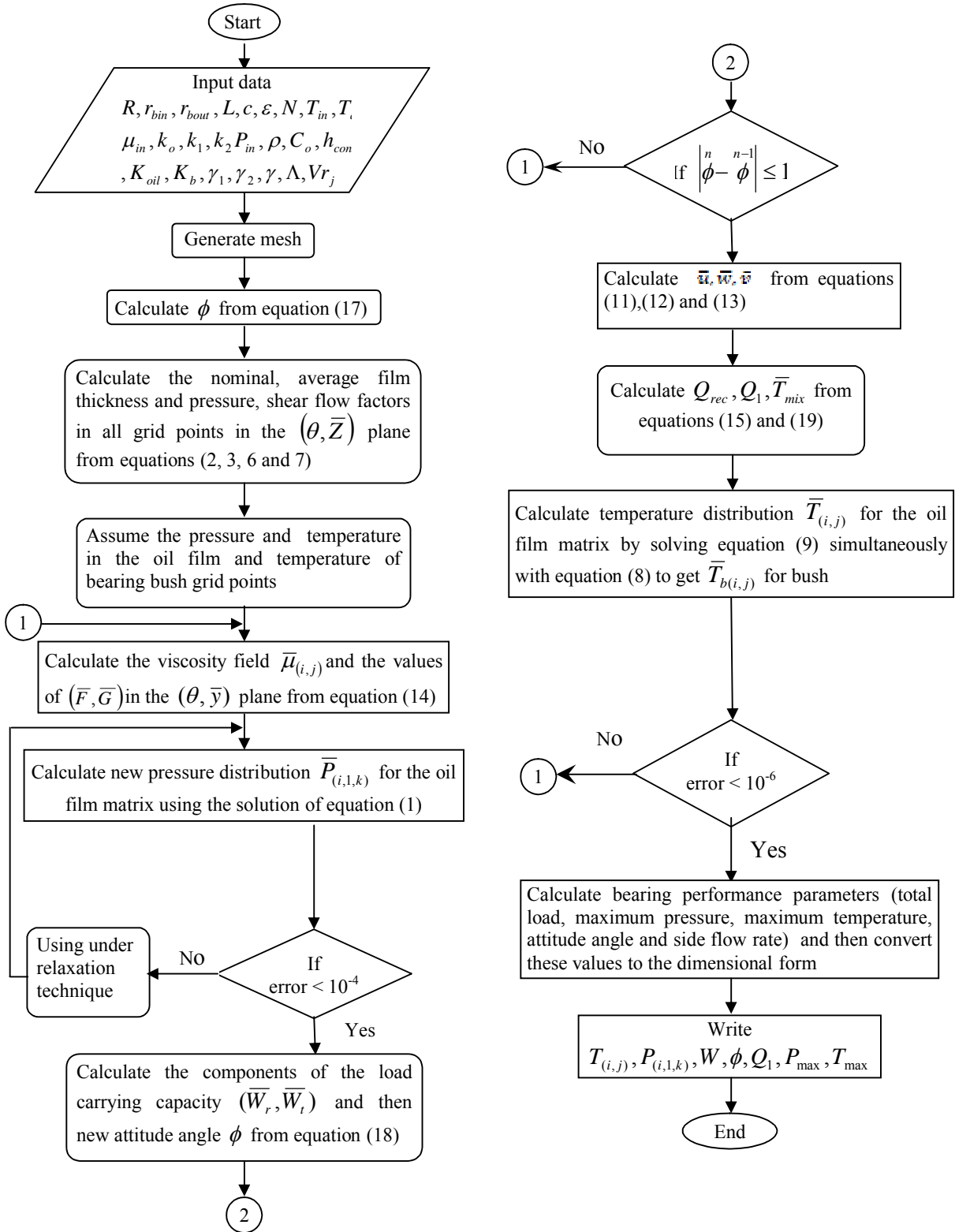

تأثير خشونة السطح على الاداء الحراري للمساند المقعدية منحرفة المحاور

باسم عجیل عباس
مصطفى محمد كاظم
قسم هندسة الميكانيك/ كلية الهندسة/ جامعة بابل

الخلاصة

تم في هذا البحث اعتماد طريقة لدراسة تأثير خشونة السطح للمساند المقعدية منحرفة المحور على الاداء الحراري لتلك المساند وذلك بأخذ نمذجة مع دل الجريان بنظر الاعتبار واشتقاق معادلات الجريان القصية لوضعية مختلفة لخشونة السطح وبشكل مماثل لمعادلات الجريان المضطربة اعتماداً على معادلة رينولدز التي تتضمن معاملات الجريان القصية والضغطية والتي يمكن الحصول عليها عن طريق النمذجة التجريبية للجريان واسخدام السطوح ذات الخشونة المقاسة وتلك التي يمكن توليدها علمياً لإيجاد الحاكمة للموضوع والتنبؤ من معادلة رينولدز، معادلة الطاقة، معادلة انتقال الحرارة بالتوصيل، ومعادلة اللزوجة التي تُعتبر اعتباراً اعتماد اللزوجة على درجات الحرارة، انبعاثاً باستخدام طريقة عديدة مشددة بطريقة الفروق المتعددة وذلك للحصول على توزيعات الحرارة ودرجات الحرارة خلال طبقة الزيت للمسند المقعدية. تم الحصول على المعادلات لسطوح خشونة متماثلة في جميع الاتجاهات واخرى ذات مواصفات اتجاهية تم ايجاد معادلات الجريان لها لتستخدم كعلاقات تجريبية بدلالة المعاملات (h/σ) والتي تعرف بانها نسبة علاقة الطول باتجاهي (x, y) . أظهرت النتائج المستحصلة خلال العمل زيادة في حمل المسند للاحمال وزيادة قيمة الضغوط الاعظم وانخفاض في قيمة درجة الحرارة الاقصى ليبلغها الزيت في حالة السطوح ذات الخشونة الثابتة (stationary surface roughness) التي تعدي المساند التي يكون فيها السطح الداخلي للمسند خشناً وسطح المحور ناعماً.