

## Research Paper

## Numerical Methodology to Obtain the Sound Absorption of Materials by Inserting the Acoustic Impedance

Cláudia Ohana BORGES MENDES\*, Maria Alzira DE ARAÚJO NUNES

Graduate Program in Engineering Materials Integrity, University of Brasília-UnB, College UnB Gama-FGA  
Área Especial de Indústria Projeção A, Setor Leste, CEP:72.444-240, Gama, Distrito Federal, Brazil

\*Corresponding Author e-mail: claudiaohanamendes@hotmail.com

(received October 8, 2020; accepted June 30, 2021)

Numerical models allow structural characteristics to be obtained by solving mathematical formulations. The sound absorption capacity of a material can be acquired by numerically simulating an impedance tube and using the method governed by ISO 10534-2. This study presents a procedure of obtaining sound pressure using two microphones and as outline condition, at one end of the tube, the impedance of fiber samples extracted from the pseudostem of banana plants. The numerical methodology was conducted in the ANSYS® Workbench software. The sound absorption coefficient was obtained in the MATLAB® software using as input data the sound pressure captured in the microphones and applying the mathematical formulations exposed in this study. For the validation of the numerical model, the results were compared with the sound absorption coefficients of the fiber sample collected from an experimental procedure and also with the results of a microperforated panel developed by MAA (1998). According to the results, the methodology presented in this study showed effective results, since the largest absolute and relative errors were 0.001 and 3.162%, respectively.

**Keywords:** impedance tube; ANSYS®; finite element method; sound absorption.



Copyright © 2021 C.O. Borges Mendes, M.A. de Araújo Nunes  
This is an open-access article distributed under the terms of the Creative Commons Attribution-ShareAlike 4.0 International (CC BY-SA 4.0 <https://creativecommons.org/licenses/by-sa/4.0/>) which permits use, distribution, and reproduction in any medium, provided that the article is properly cited, the use is non-commercial, and no modifications or adaptations are made.

## 1. Introduction

The choice of acoustic materials that can fulfil the required function in a project is made through the study of the performance characteristics of such materials. Of the fundamental characteristics to be considered when deciding which material to use, one of the main ones is its sound absorption capacity. There are several methods capable of providing such a property accurately, such as procedures: experimental, numerical and analytical.

Sound absorption is the capacity a material has to absorb sound energy. The parameter that denominates such a characteristic is the sound absorption coefficient ( $\alpha$ ), such a magnitude is indicated by an interval of values from 0 to 1. This value corresponds to the sound absorption at a given frequency, the closer to 1 the greater the absorption.

The sound absorption of a material varies according to its acoustic impedance. RIENSTRA and HIRSCHBERG (2014) define impedance as a measure of the quantity of sound energy that a surface is capable of

retaining. Furthermore, acoustic impedance is given as the result of the division between sound pressure and volume velocity (speed of sound multiplied by the surface of the material) (KINSLER *et al.*, 2000). From the impedance of a material it is possible to obtain its sound absorption coefficients, which vary with frequency.

There are several methodologies that can be used to calculate the sound absorption coefficient, such as ISO 354:2003 which provides a procedure for obtaining the sound absorption coefficient by operating a reverberant chamber and an omnidirectional microphone. Among the methodologies using an impedance tube at ISO 10534-1:1996 and ASTM C354:2003 establish the procedure for the calculation of the coefficient by capturing the sound pressure with a microphone and ASTM E1050:2019 and ISO 10534-2:1998 with two microphones.

Determining the sound absorption coefficient through the impedance tube is a technique of easy implementation and efficacy. In addition to the microphones, the impedance tube consists of a speaker that is responsi-

ble for moving the sound pressure inside the tube, and at the opposite end the sample to be tested is positioned. The procedure for capturing sound pressure in microphones can be conducted using several methods, one of which is simulation by a numerical method that is capable of representing the material and equipment studied.

Using numerical methods to characterize a system allows a better analysis of its characteristics. One of the examples of this application is the Finite Element Method (FEM). This method consists of discretizing a body, which enables a detailed, precise and effective analysis of the characteristics of the material studied. The FEM observes the behaviour of a structure by solving the differential equations that govern it, this method can be used for the study of several materials, such as plates, tubes, beams and trusses (SORIANO, 2009).

Among the numerical methodologies applied for the solution of acoustic problems where the focus is on the determination of the sound absorption coefficient and applying the FEM, MING-HUI *et al.* (2010) simulated a perforated panel using ANSYS<sup>®</sup> APDL software. SILVA *et al.* (2013) analyzed a microperforated panel using the same software. What the studies mentioned above have in common is the absence of details of the insertion method or impedance calculation of the material in the respective operated software.

This work presents a numerical procedure of insertion, at one end of the tube, of the impedance of a fiber sample from the pseudostem of banana plants and a microperforated panel (MPP) developed by MAA (1998). For this methodology a finite element method mesh was applied and as a result, in the ANSYS<sup>®</sup> Workbench software, sound pressure was obtained at specific points along the tube, these points represent the insertion location of the microphones. Subsequently the sound pressure was imported into the MATLAB<sup>®</sup> software, where the sound absorption coefficients were calculated. For the validation of the numerical model, the results were compared with the values obtained in the experimental procedure using the fiber sample and also with the data from MAA (1998).

## 2. Mathematical formulations

The sound absorption coefficients of materials can be obtained from various methodologies, one of which is ISO 10534-2, which quickly and clearly establishes the mathematical concepts for the calculation of the coefficients using the transfer function technique. For this analysis the sound pressure values obtained by two microphones inserted in the impedance tube are used.

The waves that propagate inside the impedance tube must be exclusively plane, to ensure that this oc-

curs, the cut-off frequency ( $f_c$ ) or maximum frequency, is calculated for the tube studied.

$$f_c = \frac{1.85c}{d\pi}, \quad (1)$$

where  $c$  is the speed of sound, adopted as 343 m/s and  $d$  is the diameter of the tube [m].

Figure 1 presents the nomenclatures considered in the spacings in the impedance tube. The length of the tube is indicated as  $L$ , the spacings between the sample and microphones 2 and 1 are indicated per 1 and  $S$ , respectively. In addition, the direction of the incident and reflected waves is presented.

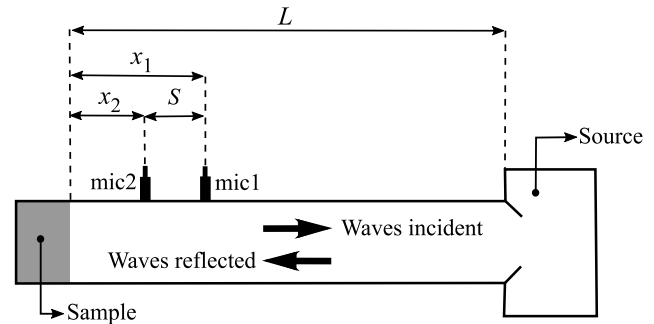

Fig. 1. Impedance tube system (LARA *et al.*, 2016).

The sound absorption coefficient ( $\alpha$ ) is calculated according to the equation:

$$\alpha = 1 - |r|^2, \quad (2)$$

where  $r$  is the reflection coefficient of sound.

$$r = \frac{H_{12} - H_I}{H_R - H_{12}} e^{2jkx_1}, \quad (3)$$

where  $H_{12}$  is the transfer function calculated by the signal obtained by the microphones at position 1 and 2,  $H_I$  and  $H_R$  are the transfer function for the incident and reflected waves, respectively,  $K$  represents the number of waves and  $x_1$  is the distance between the sample and the microphone position 1

$$H_I = e^{-jk(x_1-x_2)} = e^{-jks}, \quad (4)$$

$$H_R = e^{jk(x_1-x_2)} = e^{jks}, \quad (5)$$

where  $s$  is the distance between the microphones [m] and  $x_2$  is the distance between the sample and the microphone located at position 2;

$$k = \frac{2\pi f}{c} \quad (6)$$

in which  $f$  is the frequency [Hz].

The  $H_{12}$  transfer function is calculated from the relation between the sound pressure captured in the two microphones:

$$H_{12} = \frac{S_{12}}{S_{11}} \quad (7)$$

$S_{12}$  is the cross spectrum between microphones 1 and 2, and  $S_{11}$  is the spectrum of microphone 1.

The acoustic impedance of a material is presented by its real value ( $re$ ), or acoustic resistance, and the imaginary value ( $X$ ), or acoustic reactance

$$Z = re + iX. \quad (8)$$

### 3. Methodology

For the development of this study two commercial BSWA impedance tubes (model SW 466 of 30 and 60 mm internal diameter) were used. The tube measures were used to carry out the numerical simulation. In addition, for the determination of the impedance to be used as a boundary condition and for the validation of the results, an experimental procedure was employed where the tubes were handled.

Simulating tubes (Fig. 2) have holes through which two microphones are inserted simultaneously to pick up the sound pressure inside the tube. At one end of the tube there is a sound source emitting white noise, at the opposite end a sample is positioned.

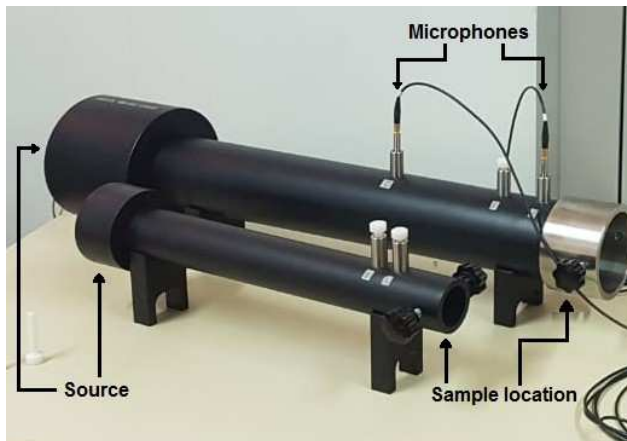

Fig. 2. Commercial impedance tube BSWA model SW 466.

#### 3.1. Calculation of the frequency range

To cover a wide frequency range, two tubes were simulated, each having 30 and 60 mm of internal diameter and 400 and 500 mm of length, respectively (Fig. 3).

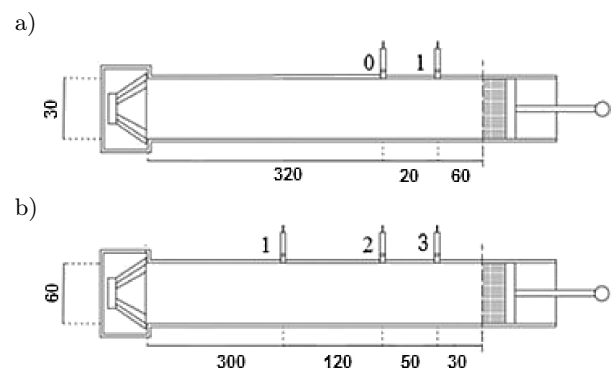

Fig. 3. Simulated tube dimensions [mm].

In a numerical simulation it is necessary to enter some input parameters. In this one it was considered: speed of sound  $c = 343$  m/s and reference pressure  $p = 2 \cdot 10^{-5}$  N/m<sup>2</sup>.

To obtain results in a wide frequency range, 3 cases were considered: 2 cases in the 60 mm diameter tube with the distinction of the position of the microphones, and 1 in the 30 mm diameter tube. To determine the frequency range that will be adopted in each simulation, it is necessary to calculate the minimum and maximum acceptable frequency for each case studied. The frequencies are calculated according to Eqs (9) and (10), developed by BÖDEN and ABON (1984)

$$f_{\min} = \frac{0.1c}{2s}, \quad (9)$$

$$f_{\max} = \frac{0.8c}{2s}, \quad (10)$$

where  $c$  is the speed of sound and  $s$  the spacing between the microphones [m].

The frequency range used in each case must be within the frequency range obtained with the resolution of Eqs (9) and (10). Table 1 presents the simulated cases as well as the spacing between the microphones considered in the analysis and the calculated and adopted minimum and maximum frequencies.

#### 3.2. Geometry development

Using ANSYS® Workbench software, the first step in the numerical simulation of the impedance tube is the creation of the geometry. To achieve this, one tube with length of 400 mm and internal diameter of 30 mm

Table 1. Simulated cases, microphone spacing and frequency range.

Tube	Case	Microphones	Microphone spacing [mm]	Calculated frequency		Adopted frequency	
				$f_{\min}$ [Hz]	$f_{\max}$ [Hz]	$f_{\min}$ [Hz]	$f_{\max}$ [Hz]
1 ( $\phi$ 60 mm)	1	1–3	170	100	807	100	800
	2	2–3	50	343	2744	400	2500
2 ( $\phi$ 30 mm)	3	0–1	20	858	6860	1000	6300

(Fig. 4) and the second one with a length of 500 mm and an internal diameter of 60 mm were created. The tube diameter was built on the  $xy$  axes and the length on the  $z$  axis.

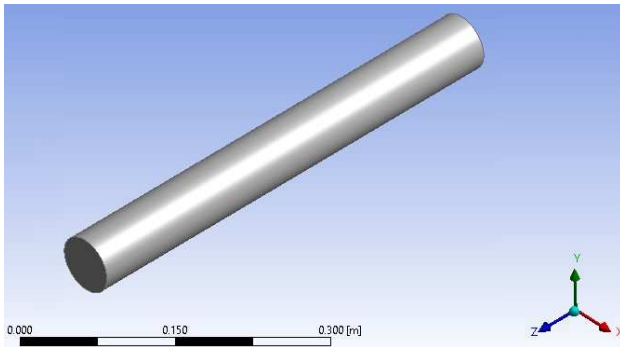

Fig. 4. Tube geometry.

### 3.3. Application of the mesh

After the geometry development, the mesh is applied over the tube. The Eq. (11) of HOWARD and COZZALATO (2014) was used to define the size of each element that constitutes the mesh

$$e_{\text{size}} = \frac{c}{f_c} \cdot \frac{1}{e_{pw}}, \tag{11}$$

$e_{pw}$  is the number of nodes per wavelength, considered equal to 20, and  $f_c$  the cutting frequency calculated according to Eq. (1) and obtaining as results 6696 for the 30 mm diameter tube and 3348 for the 60 mm tube.

The resolution of Eq. (11) presented as results 2 and 5 mm for the tube of 30 and 60 mm of internal diameter, respectively. This is the maximum acceptable value for each mesh element. For the discretization of both tubes the size of 1 mm was considered.

The mesh applied to the tube (Fig. 5) has hexahedral elements of type FLUID30 (3D Acoustic Fluid), such elements are used in 3D acoustic elements with 8 nodes, each node having 4 degrees of freedom (displacement in  $x$ ,  $y$ ,  $z$ , and sound pressure  $p$ ).

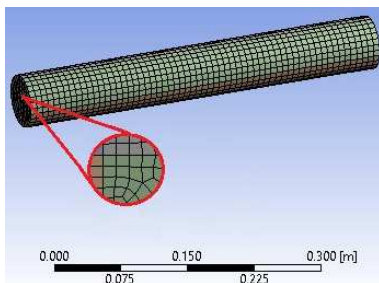

Fig. 5. Impedance tube discretized.

In order to ensure that the mesh applied guarantees reliable results, at the end of the development of the numerical model, the convergence of the mesh

was carried out. For the 60 mm diameter tube, simulations were started with the elements having 100 mm, new simulations were performed until the elements had 1 mm, with a 10 mm interval. For the 30 mm diameter tube, the simulation was started with the elements having 10 mm until it reached 1 mm, with the range of 1 mm.

### 3.4. Boundary conditions

In the physical impedance tube there is a sound source which is located at one end of the tube, for the representation of it, in the numerical simulation, an excitation called mass source was inserted. Such excitation simulates the movement of the fluid at the points where it was selected, the movement is transferred to the next nodes, similarly to what occurs in a real sound source.

At the opposite end of the sound source is located the sample which is to be checked for sound absorption coefficient. Among the possible methods capable of representing a material, there is the insertion of its impedance in the nodes where the material is positioned. The material impedance can be calculated from an analytical, numerical or experimental methodology. In this study the impedance obtained from an experimental procedure was used. The acquisition was conducted in the VA-Lab4 software and two samples of fiber extracted from the pseudostem of banana plants, were used. The same samples were used for the validation of this numerical simulation.

The boundary condition, on the ANSYS® Workbench, capable of inserting the impedance depending on the frequency is called the *Impedance Boundary* (Fig. 6). After selecting the boundary condition, you define the faces where the boundary condition is applied (Fig. 7).

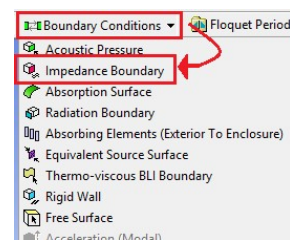

Fig. 6. Impedance boundary condition.

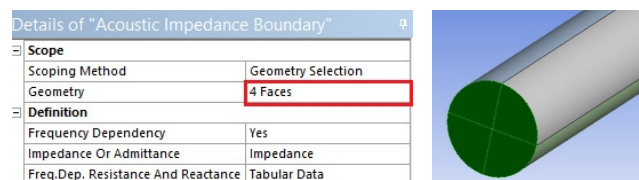

Fig. 7. Selection of faces for impedance insertion.

The impedance of the samples is composed of the real (resistance) and imaginary (reactance) part and is

dependent on the frequency, which varies in intervals of 2 Hz. For the impedance insertion a table is created (Fig. 8a) where the frequencies with the respective resistance and reactance are inserted (Fig. 8b).

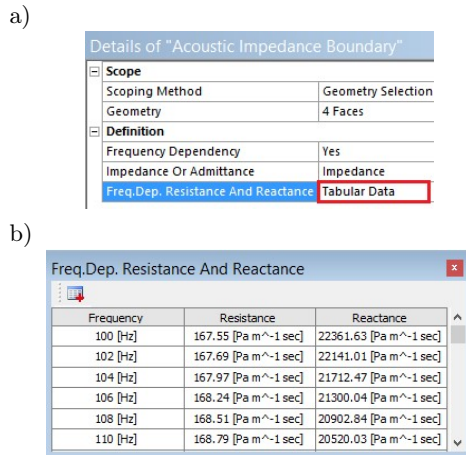

Fig. 8. Creation of the table to insert the impedance: a) table selection location, b) data insertion.

After applying the contour conditions (Fig. 9), the entire tube geometry was selected and an acoustic body was applied using the *Acoustic Body* option.

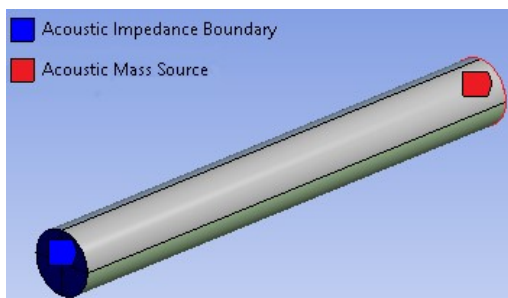

Fig. 9. Boundary conditions applied in the impedance tube.

### 3.5. Sound pressure capture

The next step, after defining the boundary conditions, is the insertion of the points through which the sound pressure is captured inside the tube. The points where the microphones are located are the nodes located at a predetermined point on the  $z$ -axis. The sound pressure is captured at two points (Fig. 10) simultaneously, according to the precepts of ISO 10534-2, which uses two microphones to calculate the sound ab-

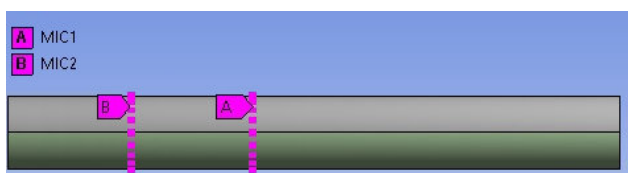

Fig. 10. Selection of nodes for sound pressure capture.

sorption coefficient. The points used in each case are shown in Table 2.

Table 2. Sound pressure capture points.

CASE	Microphone location [m]	
	1	2
1	0.30	0.47
2	0.42	0.47
3	0.32	0.34

In the ANSYS<sup>®</sup> Workbench software the results of the acoustic pressures (real and imaginary) were obtained by the frequency range indicated for each case. The pressures were imported into the MATLAB<sup>®</sup> software, where sound absorption coefficients were calculated using the mathematical equations indicated in Sec. 2. Finally, graphs were created showing the coefficients by the respective frequencies indicated in each case, ranging from 100 to 6300 Hz.

### 3.6. Validation of results

The validation of the numerical methodology was performed by comparing the results acquired in the numerical procedure with those obtained with the experimental methodology and also with the results obtained by MAA (1998) from an analytical methodology.

The experimental procedure was conducted by operating the 30 and 60 mm internal diameter impedance tubes, presented in Fig. 2, and in the VA-Lab4 software. The technique used was the transfer function between two microphones, described in ISO 10534-2.

For the comparison we obtained the coefficients of two samples of fiber extracted from the pseudostem of banana plants (Fig. 11), each 30 and 60 mm in diameter, 7 mm thick and 120 kg/m<sup>2</sup>. The experimental test with the 60 mm sample provided results in the frequency range of 100 to 2500 Hz and, with the 30 mm sample, coefficients were obtained in the frequency range of 1000 to 6300 Hz.



Fig. 11. Samples used in the experimental procedure.

Besides the validation by the experimental methodology, the sound absorption coefficients of MPP developed by MAA (1998) were generated. In order to obtain the results, the impedance of the material was used, which was positioned at one end of the tube developed in the methodology of this study.

For validation, results were generated for two different cases with the 60 mm tube: covering the frequency range from 100 to 800 Hz in case 1 and 400 to 2500 Hz in case 2. With the 30 mm tube, case 3, results were collected in the range from 1000 to 5000 Hz. As can be seen in Subsec. 3.1, the maximum frequency range that can be used in the 30 mm tube is 6860, however, the results of MAA (1998) are limited to 5000 Hz, making it impossible to compare with values higher than that frequency.

After obtaining the results for the 3 cases studied, the values of the numerical methodology were compared with the results of MAA (1998), giving rise to 3 graphs with different frequency ranges.

#### 4. Results

From the numerical methodology developed, where an impedance boundary condition was inserted, the sound absorption coefficients of two pseudostem of banana plants samples and also of an MPP developed by MAA (1998) in the frequency range of 100 to 6300 Hz were calculated. For the development of the methodology, the ANSYS<sup>®</sup> Workbench software was used, where the sound pressure was captured in two points that represent the insertion of the microphones. After obtaining the sound pressures, the MATLAB<sup>®</sup> software was used to calculate the coefficients.

In order to verify if the generated mesh presented trustful results, the mesh convergence was performed. Figures 12 and 13 show the convergence of the 60 and 30 mm diameter tubes, respectively. From the analysis of the figures, it can be seen that with the tube of 60 mm discretized in 2000 elements, where each element has 10 mm, and with the tube of 30 mm discretized in 40 thousand elements, where each element has 2 mm, the sound pressures are similar, proving that by discretizing the tube with quantities of elements greater than those cited the results are safe.

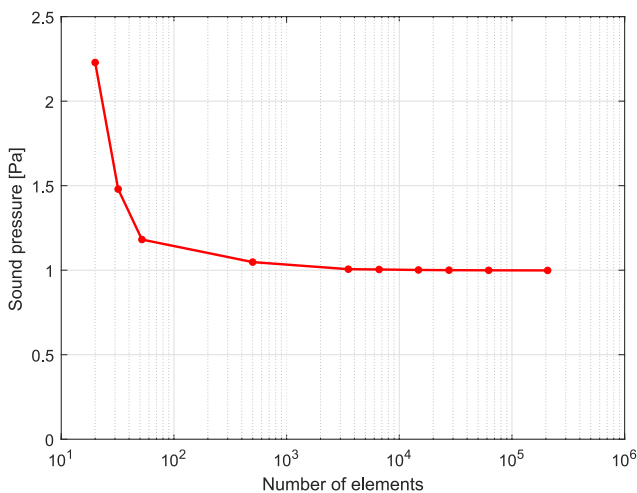

Fig. 12. 60 mm diameter tube mesh convergence analysis.

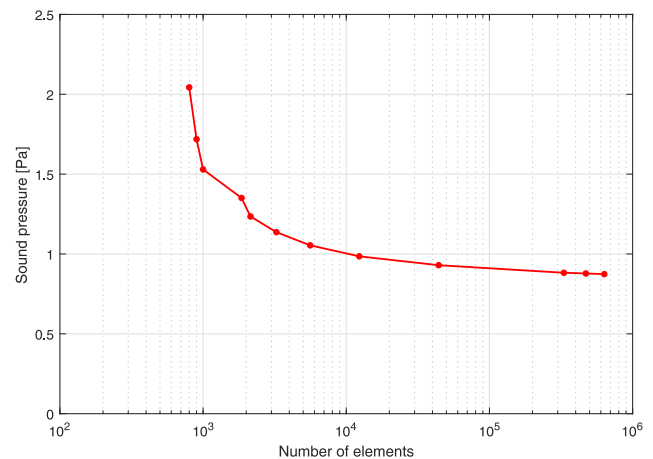

Fig. 13. 30 mm diameter tube mesh convergence analysis.

In order to validate the numerical methodology, the obtained results were compared with the sound absorption coefficients acquired from an experimental methodology, and in both methodologies two samples of the fiber extracted from the pseudostem of banana plants were used.

Three cases were simulated, in which the distinction between the results of each one is by the frequency range of work addressed. Figure 14 presents the results of case 1, obtained with the 60 mm diameter tube and the microphones with 170 mm spacing, and with results from 100 to 800 Hz. From the figure it can be seen that the results obtained with the experimental methodology (blue line) and numerical (red line) are similar. The absolute and relative errors between the methodologies were calculated, being equal to 0.002 and 1.600%, respectively.

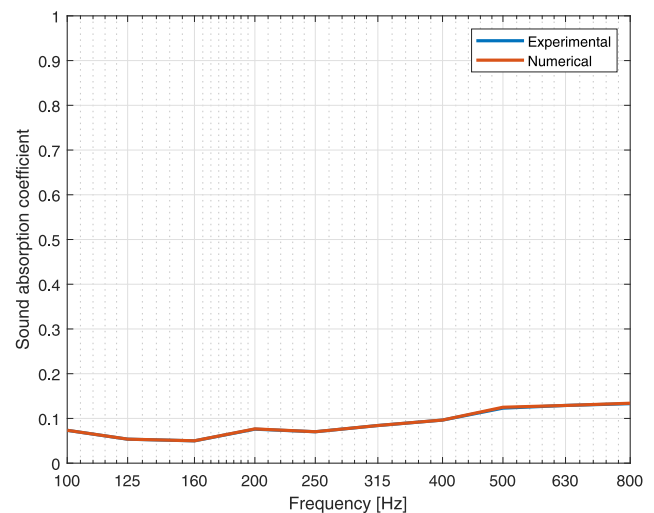

Fig. 14. Comparison between numerical (red line) and experimental (blue line) methodology for case 1.

Case 2 represents the simulation with the 60 mm diameter tube and the microphones having a 50 mm spacing. The results of this case, which covers the fre-

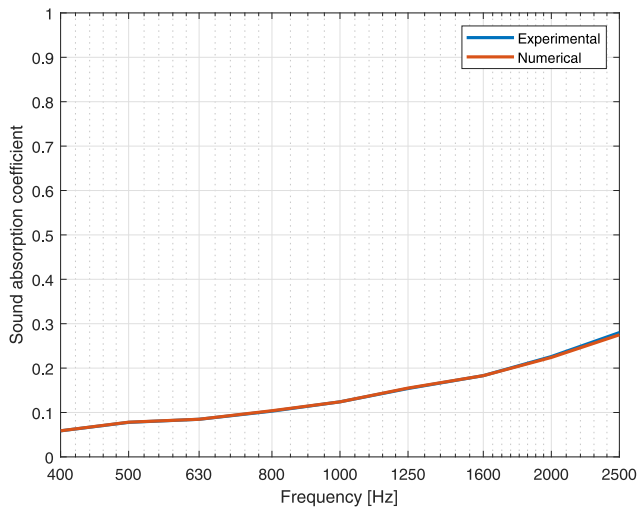

Fig. 15. Comparison between numerical (red line) and experimental (blue line) methodology for case 2.

quency range from 400 to 2500 Hz, are shown in Fig. 15 (red line). In addition, in the same figure, there are the results of the experimental methodology (blue line). By comparing the results the absolute and relative maximum error is 0.001 and 1.818%, respectively.

Finally, there are the results of case 3, which is the simulation in the 30 mm tube and the microphones with the spacing of 20 mm, which allowed a working frequency range of 1000 to 6300 Hz. With the results of numerical simulation (red line) and experimental procedure (blue line), presented in Fig. 16, it is worth noting that the results are similar, having as absolute and relative maximum error 0.008 and 3.162%, respectively.

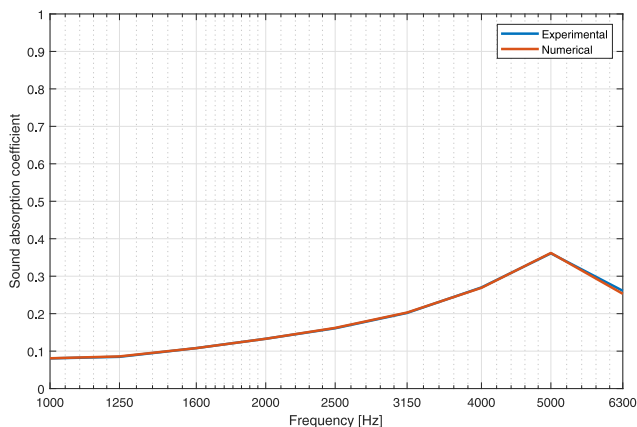

Fig. 16. Comparison between numerical (red line) and experimental (blue line) methodology for case 3.

Besides the validation from an experimental procedure, the results of the sound absorption coefficients of MPP developed by MAA (1998) were generated, the values were compared with those calculated by the author. Figures 17, 18, and 19 present the numerical

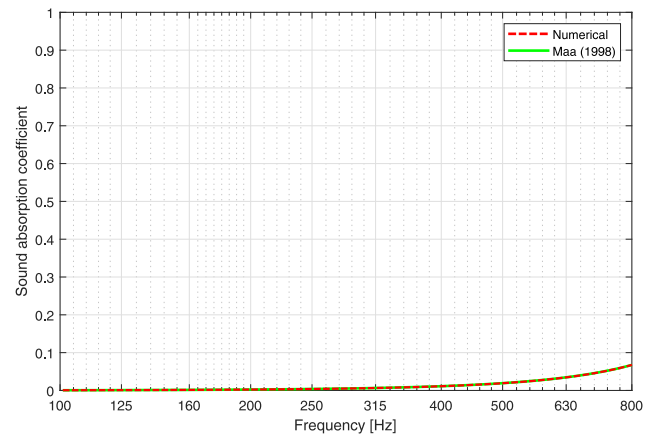

Fig. 17. Comparison between numerical methodology (red line) and MAA (1998) data (green line) for case 1.

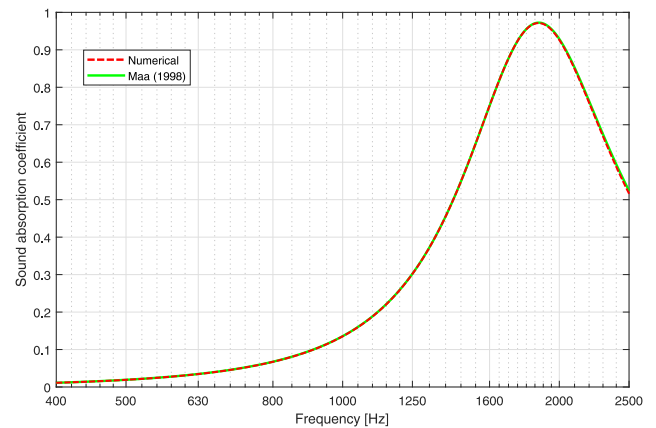

Fig. 18. Comparison between numerical methodology (red line) and MAA (1998) data (green line) for case 2.

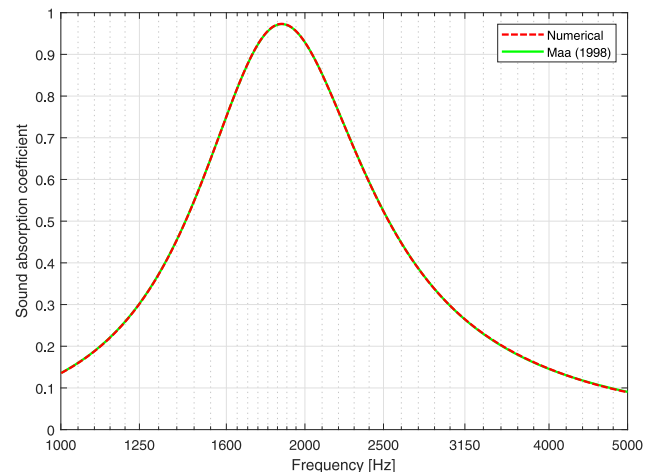

Fig. 19. Comparison between numerical methodology (red line) and MAA (1998) data (green line) for case 3.

simulation (red line) and the coefficients calculated by MAA (1998) (green line) for the 3 cases studied.

From the comparison between the numerical simulation results and those of MAA (1998), in the 60 mm diameter tube, in case 1 (Fig. 17), the maximum ab-

solute error of 0.000 and the relative error of 0.492% were obtained, while in case 2 (Fig. 18), the absolute and relative errors were 0.012 and 3.083%, respectively. In case 3, simulation with the 30 mm diameter tube (Fig. 19), the maximum absolute error was 0.001 and the relative 1.088%.

## 5. Conclusion

This study presented a numerical methodology conducted in the ANSYS<sup>®</sup> Workbench software to obtain sound pressure at two specific points along a tube that represents an impedance tube, for this purpose, an impedance boundary condition was positioned at one end of the tube. The simulation used the impedance of a fiber sample extracted from the pseudostem of banana plants collected from an experimental procedure, and also used the MPP impedances developed by MAA (1998). After obtaining the sound pressure, the sound absorption coefficients of the fibre and MPP samples were calculated in the MATLAB<sup>®</sup> software using the formulations of ISO 10543-2. For the validation of the results, the coefficients were compared with those obtained by an experimental procedure in the impedance tube and also with the results of MAA (1998), which generated its results by means of an analytical methodology.

The size of the elements that form the mesh applied in the tube by FEM was established by the resolution of Eq. (11) and the convergence of mesh. The resolution of the equation indicated that the discretization of the mesh should be made in elements with sizes smaller than 2 and 5 mm in the tube of 30 and 60 mm, respectively. This was confirmed by the results of the mesh convergence, which indicated that by discretizing tubes of 30 and 60 mm in elements less than or equal to 2 and 10 mm, respectively, reliable results are obtained.

From the validation of the numerical methodology it was observed that, through comparison with the experimental methodology, the greatest absolute and relative error was 0.008 and 3.162%, respectively, and occurred in case 3. In the validation with the data from MAA (1998), the largest absolute error was 0.012 and the relative 3.083%. From the errors cited it can be seen that the variations between the results are small, being close to 0, proving the effectiveness of the methodology developed in this study.

## References

1. ASTM E1050:2019, *Standard test method for impedance and absorption of acoustical materials using a tube, two microphones and a digital frequency analysis system*.
2. ASTM E354:2003, *Acoustics – measurement of sound absorption in a reverberation room*.
3. BÓDEN H., ABOM M. (1986), Influence of errors on the two-microphone method for measuring acoustic properties in ducts, *The Journal of the Acoustical Society of America*, **79**(2): 541–549, doi: 10.1121/1.393542.
4. MING-HUI G., QING-QUAN H., JIN-MAN W., HAI-PENG Y. (2010), The modeling and simulation analysis of wooden perforated panel absorption structure, *Noise & Vibration Worldwide*, **41**(10): 72–75, doi: 10.1260/0957-4565.41.10.72.
5. HOWARD C.Q., CAZZOLATO B.S. (2014), *Acoustic Analyses using MATLAB<sup>®</sup> and ANSYS<sup>®</sup>*, Boca Raton: CRC Press, Taylor & Francis Group.
6. ISO 10534-1:1996, *Acoustic – Determination of sound absorption coefficient and impedance in impedance tubes – Part 1: Method using standing wave ratio*.
7. ISO 10534-2:1998, *Acoustics – Determination of sound absorption coefficient and impedance in impedance tubes. Part 2: Transfer-function method*.
8. ISO 354:2003, *Measurement of sound absorption in a reverberant room*.
9. KINSLER L.E., FREY A.R., COPPENS A.B., SANDERS J.V. (2000), *Fundamentals of Acoustics*, Hoboken: John Wiley & Sons, New York.
10. LARA L.T., BOAVENTURA W.C., PASQUAL A.M. (2016), Improving the estimated acoustic absorption curves in impedance tubes by using wavelet-based denoising methods, *Congresso Iberoamericano de Acústica*, Buenos Aires, Argentina, **22**, 1–10.
11. MAA D.Y. (1998), Potential of microperforated panel absorber, *The Journal of the Acoustical Society of America*, **104**(5): 2861–2866, doi: 10.1121/1.423870.
12. RIENSTRA S.W., HIRSCHBERG A. (2014), *An Introduction to Acoustics*, Eindhoven University of Technology, Netherlands.
13. SILVA G.C.C., NUNES M.A.A., ALMEIDA JR A.B., LOPES R.V. (2013), Acoustic design and construction of an impedance tube for experimental characterization of sound absorbed materials [in Portuguese: Projeto Acústico e Construção de um Tubo de Impedância para Caracterização Experimental de Materiais com Absorção Sonora], [in:] *XVIII Congresso de Iniciação Científica da UnB*, Brasília, Brazil.
14. SORIANO H.L. (2009), *Finite Elements – Formulation and Application in Static and Dynamic Structures* [in Portuguese: *Elementos Finitos – Formulação e Aplicação na Estática e Dinâmica das Estruturas*], Rio de Janeiro: Editora Ciência Moderna Ltda.